



Class XII : Chemistry
Chapter 10 : Biomolecules

Questions and Solutions | Page - 290 - NCERT Books

Q1 :

Glucose or sucrose are soluble in water but cyclohexane or benzene (simple six membered ring compounds) are insoluble in water. Explain.

Answer :

A glucose molecule contains five -OH groups while a sucrose molecule contains eight -OH groups. Thus, glucose and sucrose undergo extensive H-bonding with water.

Hence, these are soluble in water.

But cyclohexane and benzene do not contain -OH groups. Hence, they cannot undergo H-bonding with water and as a result, are insoluble in water.

Q2 :

What are the expected products of hydrolysis of lactose?

Answer :

Lactose is composed of β -D-galactose and β -D-glucose. Thus, on hydrolysis, it gives β -D-galactose and β -D-glucose.

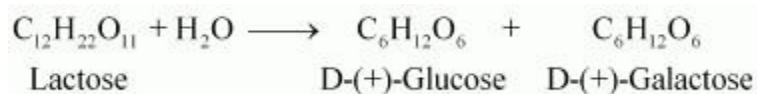
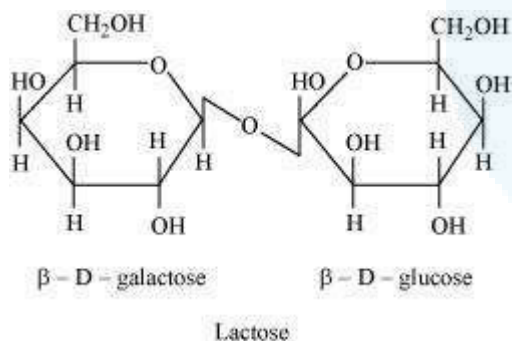



Q3 :

How do you explain the absence of aldehyde group in the pentaacetate of D-glucose?

Answer :

D-glucose reacts with hydroxylamine (NH_2OH) to form an oxime because of the presence of aldehydic ($-\text{CHO}$) group or carbonyl carbon. This happens as the cyclic structure of glucose forms an open chain structure in an aqueous medium, which then reacts with NH_2OH to give an oxime.

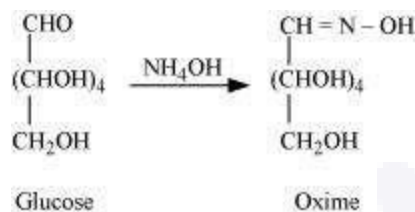

But pentaacetate of D-glucose does not react with NH_2OH . This is because pentaacetate does not form an open chain structure.

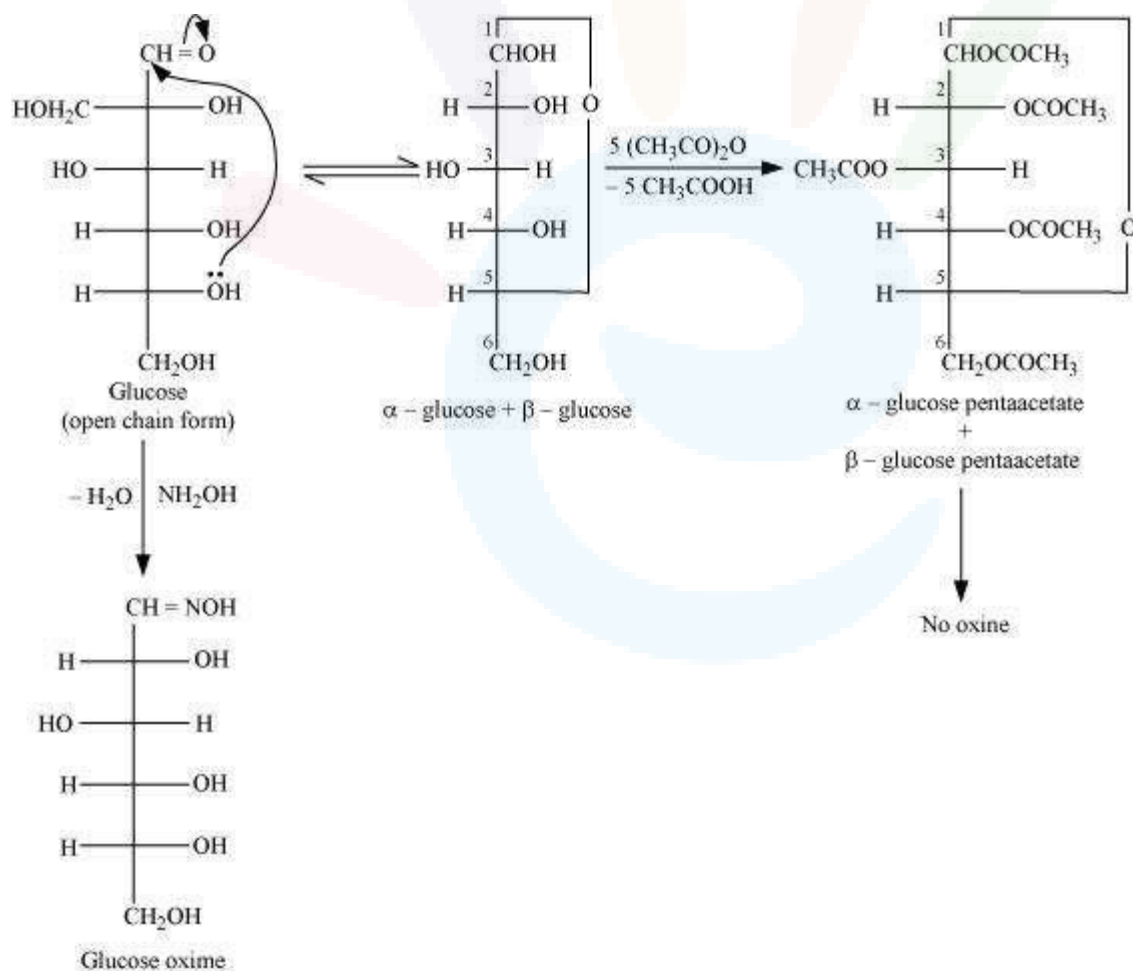



Questions and Solutions | Page - 295 - NCERT Books

Q4 :

The melting points and solubility in water of amino acids are generally higher than that of the corresponding halo acids. Explain.

Answer :

Both acidic (carboxyl) as well as basic (amino) groups are present in the same molecule of amino acids. In aqueous solutions, the carboxyl group can lose a proton and the amino group can accept a proton, thus giving rise to a dipolar ion known as a zwitter ion.

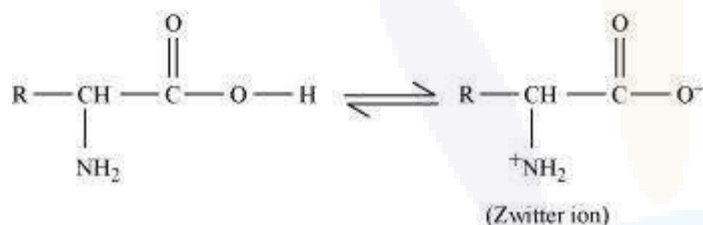

Due to this dipolar behaviour, they have strong electrostatic interactions within them and with water. But halo-acids do not exhibit such dipolar behaviour.

For this reason, the melting points and the solubility of amino acids in water is higher than those of the corresponding halo-acids.

Q5 :

Where does the water present in the egg go after boiling the egg?

Answer :

When an egg is boiled, the proteins present inside the egg get denatured and coagulate. After boiling the egg, the water present in it is absorbed by the coagulated protein through H-bonding.



Questions and Solutions | Page - 301 - NCERT Books

Q6 :

Why cannot vitamin C be stored in our body?

Answer :

Vitamin C cannot be stored in our body because it is water soluble. As a result, it is readily excreted in the urine.

Q7 :

What products would be formed when a nucleotide from DNA containing thymine is hydrolysed?

Answer :

When a nucleotide from the DNA containing thymine is hydrolyzed, thymine β -D-2-deoxyribose and phosphoric acid are obtained as products.

Q8 :

When RNA is hydrolysed, there is no relationship among the quantities of different bases obtained. What does this fact suggest about the structure of RNA?

Answer :

A DNA molecule is double-stranded in which the pairing of bases occurs. Adenine always pairs with thymine, while cytosine always pairs with guanine. Therefore, on hydrolysis of DNA, the quantity of adenine produced is equal to that of thymine and similarly, the quantity of cytosine is equal to that of guanine.

But when RNA is hydrolyzed, there is no relationship among the quantities of the different bases obtained. Hence, RNA is single-stranded.



Questions and Solutions | Exercises - Page - 302 - NCERT Books

Q1 :

What are monosaccharides?

Answer :

Monosaccharides are carbohydrates that cannot be hydrolysed further to give simpler units of polyhydroxy aldehyde or ketone.

Monosaccharides are classified on the bases of number of carbon atoms and the functional group present in them. Monosaccharides containing an aldehyde group are known as aldoses and those containing a keto group are known as ketoses. Monosaccharides are further classified as trioses, tetroses, pentoses, hexoses, and heptoses according to the number of carbon atoms they contain. For example, a ketose containing 3 carbon atoms is called ketotriose and an aldose containing 3 carbon atoms is called aldotriose.

Q2 :

What are reducing sugars?

Answer :

Reducing sugars are carbohydrates that reduce Fehling's solution and Tollen's reagent. All monosaccharides and disaccharides, excluding sucrose, are reducing sugars.

Q3 :

Write two main functions of carbohydrates in plants.

Answer :

Two main functions of carbohydrates in plants are:

- (i) Polysaccharides such as starch serve as storage molecules.
- (ii) Cellulose, a polysaccharide, is used to build the cell wall.

Q4 :

Classify the following into monosaccharides and disaccharides.

Ribose, 2-deoxyribose, maltose, galactose, fructose and lactose



Answer :

Monosaccharides:

Ribose, 2-deoxyribose, galactose, fructose

Disaccharides: Maltose, lactose

Q5 :

What do you understand by the term glycosidic linkage?

Answer :

Glycosidic linkage refers to the linkage formed between two monosaccharide units through an oxygen atom by the loss of a water molecule.

For example, in a sucrose molecule, two monosaccharide units, α -glucose and β -fructose, are joined together by a glycosidic linkage.

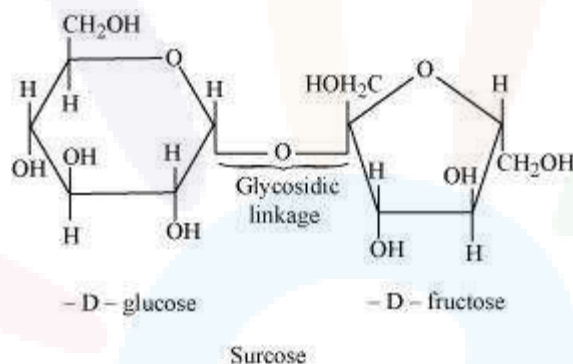

Q6 :

What is glycogen? How is it different from starch?

Answer :

Glycogen is a carbohydrate (polysaccharide). In animals, carbohydrates are stored as glycogen.

Starch is a carbohydrate consisting of two components - amylose (15 - 20%) and amylopectin (80 - 85%).

However, glycogen consists of only one component whose structure is similar to amylopectin. Also, glycogen is more branched than amylopectin.

Q7 :

What are the hydrolysis products of (i)sucrose and (ii)lactose?

Answer :

(i) On hydrolysis, sucrose gives one molecule of α -D glucose and one molecule of β -D-fructose.

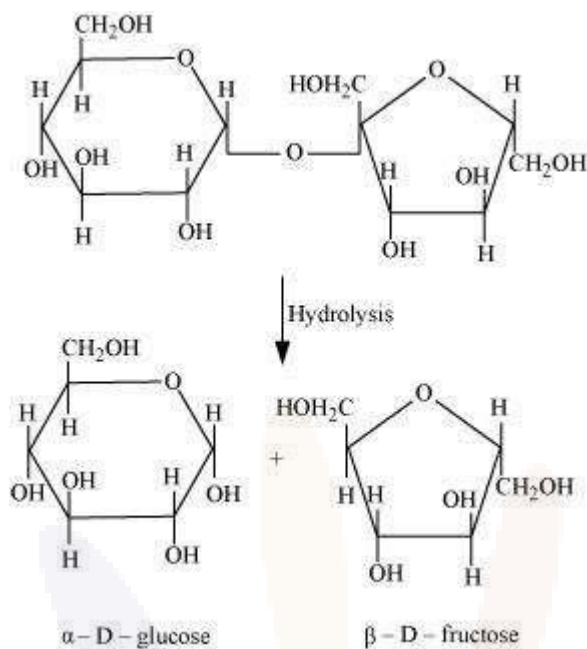

(ii) The hydrolysis of lactose gives α -D-galactose and α -D-glucose.

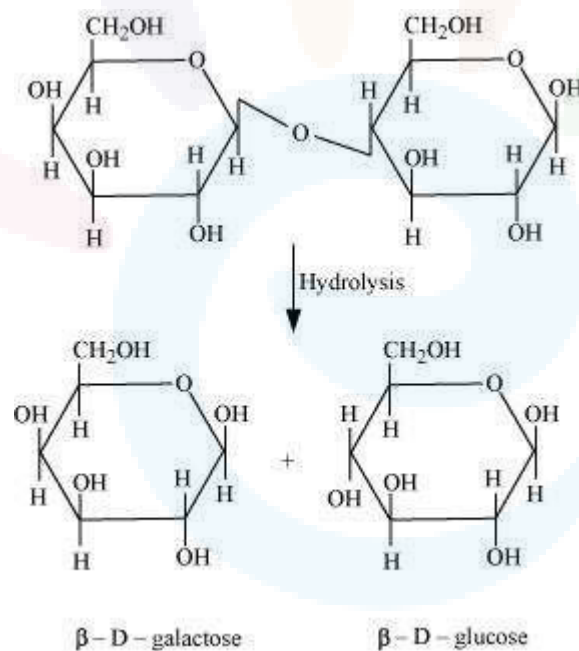

Q8 :

What is the basic structural difference between starch and cellulose?

Answer :

Starch consists of two components - amylose and amylopectin. Amylose is a long linear chain of α -D-(+)-glucose units joined by C1-C4 glycosidic linkage (α -link).

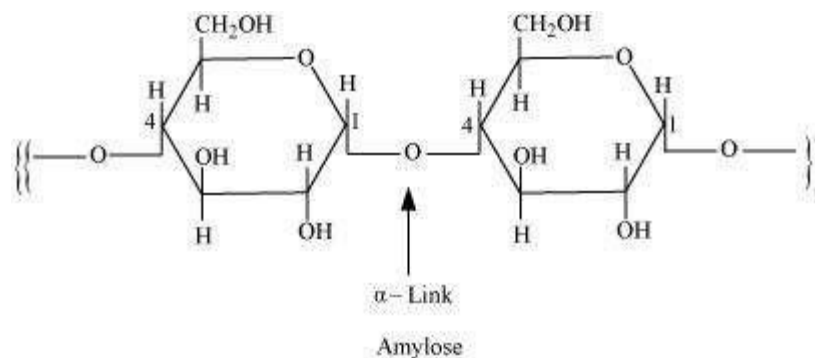

Amylopectin is a branched-chain polymer of α -D-glucose units, in which the chain is formed by C1-C4 glycosidic linkage and the branching occurs by C1-C6 glycosidic linkage.

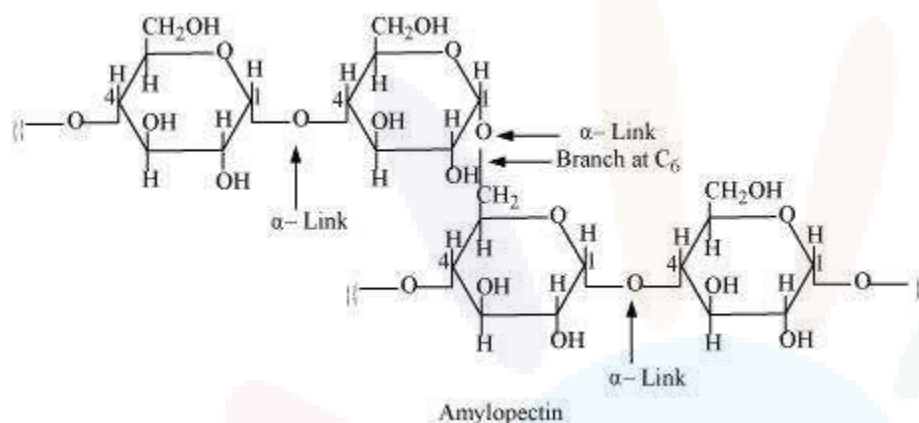

On the other hand, cellulose is a straight-chain polysaccharide of β -D-glucose units joined by C1-C4 glycosidic linkage (β -link).

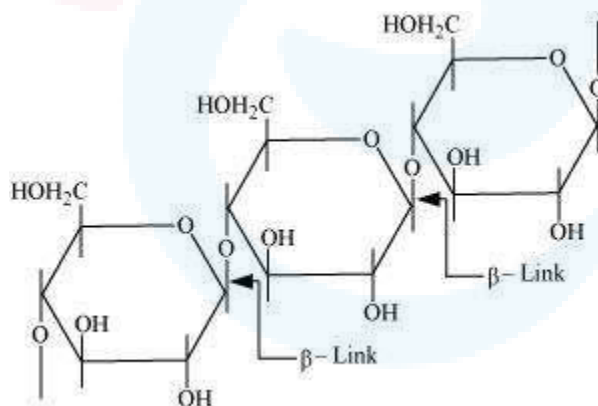

Q9 :

What happens when D-glucose is treated with the following reagents? (i)

HI (ii) Bromine water (iii) HNO₃

Answer :

(i) When D-glucose is heated with HI for a long time, n-hexane is formed.

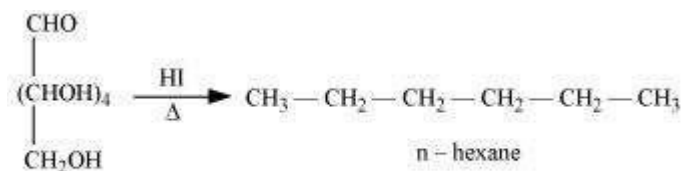

D - glucose

(ii) When D-glucose is treated with Br₂ water, D- gluconic acid is produced.

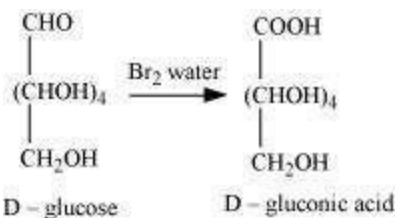

(iii) On being treated with HNO₃, D-glucose get oxidised to give saccharic acid.

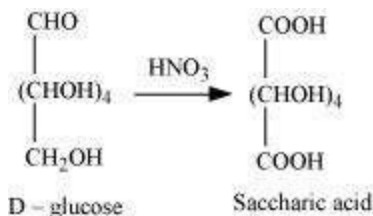

Q10 :

Enumerate the reactions of D-glucose which cannot be explained by its open chain structure.

Answer :

- (1) Aldehydes give 2, 4-DNP test, Schiff's test, and react with NaHSO₃ to form the hydrogen sulphite addition product. However, glucose does not undergo these reactions.
- (2) The pentaacetate of glucose does not react with hydroxylamine. This indicates that a free -CHO group is absent from glucose.
- (3) Glucose exists in two crystalline forms - α and β. The α-form (m.p. = 419 K) crystallises from a concentrated solution of glucose at 303 K and the β-form (m.p = 423 K) crystallises from a hot and saturated aqueous solution at 371 K. This behaviour cannot be explained by the open chain structure of glucose.

Q11 :

What are essential and non-essential amino acids? Give two examples of each type.

Answer :

Essential amino acids are required by the human body, but they cannot be synthesised in the body. They must be taken through food. For example: valine and leucine

Non-essential amino acids are also required by the human body, but they can be synthesised in the body. For example: glycine, and alanine



Q12 :

Define the following as related to proteins

(i) Peptide linkage (ii) Primary structure (iii) Denaturation.

Answer :

(i) Peptide linkage:

The amide formed between -COOH group of one molecule of an amino acid and -NH₂ group of another molecule of the amino acid by the elimination of a water molecule is called a peptide linkage.

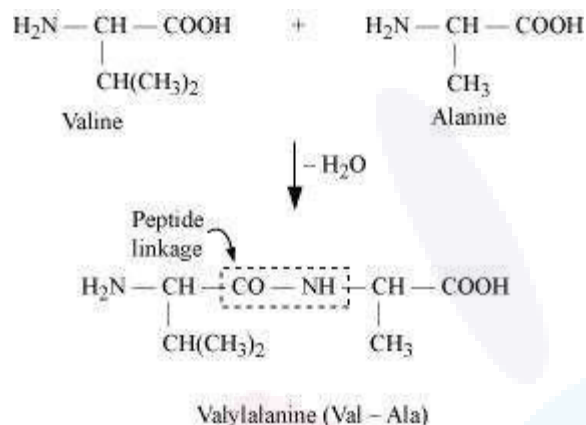

(ii) Primary structure:

The primary structure of protein refers to the specific sequence in which various amino acids are present in it, i.e., the sequence of linkages between amino acids in a polypeptide chain. The sequence in which amino acids are arranged is different in each protein. A change in the sequence creates a different protein.

(iii) Denaturation:

In a biological system, a protein is found to have a unique 3-dimensional structure and a unique biological activity. In such a situation, the protein is called native protein. However, when the native protein is subjected to physical changes such as change in temperature or chemical changes such as change in pH, its H-bonds are disturbed. This disturbance unfolds the globules and uncoils the helix. As a result, the protein loses its biological activity. This loss of biological activity by the protein is called denaturation. During denaturation, the secondary and the tertiary structures of the protein get destroyed, but the primary structure remains unaltered.

One of the examples of denaturation of proteins is the coagulation of egg white when an egg is boiled.

Q13 :

What are the common types of secondary structure of proteins?

Answer :

There are two common types of secondary structure of proteins:

- (i) α -helix structure
- (ii) β -pleated sheet structure



In this structure, the -NH group of an amino acid residue forms H-bond with the $\text{C}=\text{O}$ group of the adjacent turn of the right-handed screw α -helix.

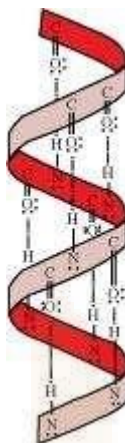

β -pleated sheet structure:

This structure is called so because it looks like the pleated folds of drapery. In this structure, all the peptide chains are stretched out to nearly the maximum extension and then laid side by side. These peptide chains are held together by intermolecular hydrogen bonds.

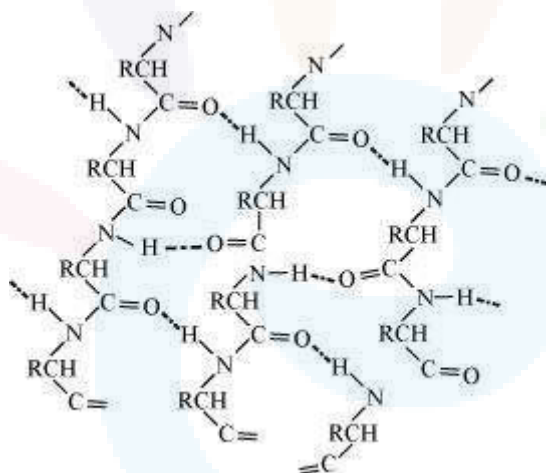

Q14 :

What type of bonding helps in stabilising the α -helix structure of proteins?

Answer :

The H-bonds formed between the -NH group of each amino acid residue and the

$\text{C}=\text{O}$ group of the adjacent turns of the α -helix help in stabilising the helix.

Q15 :

Differentiate between globular and fibrous proteins.



Answer :

Fibrous protein		Globular protein	
1.	It is a fibre-like structure formed by the polypeptide chain. These proteins are held together by strong hydrogen and disulphide bonds.	1.	The polypeptide chain in this protein is folded around itself, giving rise to a spherical structure.
2.	It is usually insoluble in water.	2.	It is usually soluble in water.
3.	Fibrous proteins are usually used for structural purposes. For example, keratin is present in nails and hair; collagen in tendons; and myosin in muscles.	3.	All enzymes are globular proteins. Some hormones such as insulin are also globular proteins.

Q16 :

How do you explain the amphoteric behaviour of amino acids?

Answer :

In aqueous solution, the carboxyl group of an amino acid can lose a proton and the amino group can accept a proton to give a dipolar ion known as zwitter ion.

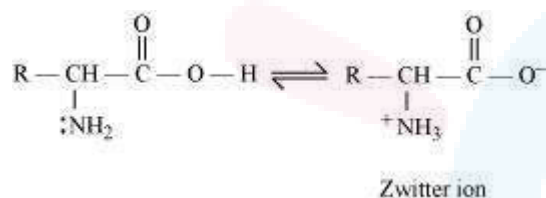

Therefore, in zwitter ionic form, the amino acid can act both as an acid and as a base.

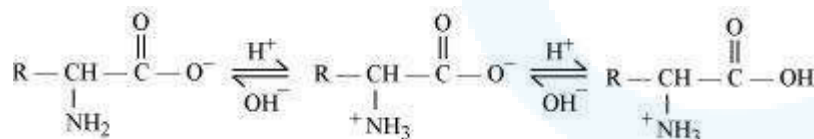

Thus, amino acids show amphoteric behaviour.

Q17 :

What are enzymes?

Answer :

Enzymes are proteins that catalyse biological reactions. They are very specific in nature and catalyse only a particular reaction for a particular substrate. Enzymes are usually named after the particular substrate or class of substrate and some times after the particular reaction.



For example, the enzyme used to catalyse the hydrolysis of maltose into glucose is named as maltase.



Again, the enzymes used to catalyse the oxidation of one substrate with the simultaneous reduction of another substrate are named as oxidoreductase enzymes.

The name of an enzyme ends with ' - ase'.

Q18 :

What is the effect of denaturation on the structure of proteins?

Answer :

As a result of denaturation, globules get unfolded and helices get uncoiled. Secondary and tertiary structures of protein are destroyed, but the primary structures remain unaltered. It can be said that during denaturation, secondary and tertiary-structured proteins get converted into primary-structured proteins. Also, as the secondary and tertiary structures of a protein are destroyed, the enzyme loses its activity.

Q19 :

How are vitamins classified? Name the vitamin responsible for the coagulation of blood.

Answer :

On the basis of their solubility in water or fat, vitamins are classified into two groups.

(i) **Fat-soluble vitamins:** Vitamins that are soluble in fat and oils, but not in water, belong to this group. For example: Vitamins A, D, E, and K

(ii) **Water-soluble vitamins:** Vitamins that are soluble in water belong to this group. For example: B group vitamins (B₁, B₂, B₆, B₁₂, etc.) and vitamin C

However, biotin or vitamin H is neither soluble in water nor in fat.

Vitamin K is responsible for the coagulation of blood.

Q20 :

Why are vitamin A and vitamin C essential to us? Give their important sources.

Answer :

The deficiency of vitamin A leads to xerophthalmia (hardening of the cornea of the eye) and night blindness. The deficiency of vitamin C leads to scurvy (bleeding gums).

The sources of vitamin A are fish liver oil, carrots, butter, and milk. The sources of vitamin C are citrus fruits, *amla*, and green leafy vegetables.



Q21 :

What are nucleic acids? Mention their two important functions.

Answer :

Nucleic acids are biomolecules found in the nuclei of all living cells, as one of the constituents of chromosomes. There are mainly two types of nucleic acids - deoxyribonucleic acid (DNA) and ribonucleic acid (RNA). Nucleic acids are also known as polynucleotides as they are long-chain polymers of nucleotides.

Two main functions of nucleic acids are:

(i) DNA is responsible for the transmission of inherent characters from one generation to the next. This process of transmission is called heredity.

(ii) Nucleic acids (both DNA and RNA) are responsible for protein synthesis in a cell. Even though the proteins are actually synthesised by the various RNA molecules in a cell, the message for the synthesis of a particular protein is present in DNA.

Q22 :

What is the difference between a nucleoside and a nucleotide?

Answer :

A nucleoside is formed by the attachment of a base to 1' position of sugar.

Nucleoside = Sugar + Base

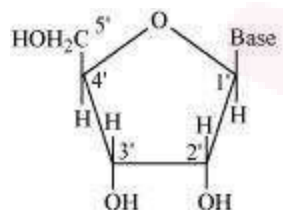

Structure of a nucleoside

On the other hand, all the three basic components of nucleic acids (i.e., pentose sugar, phosphoric acid, and base) are present in a nucleotide.

Nucleotide = Sugar + Base + Phosphoric acid

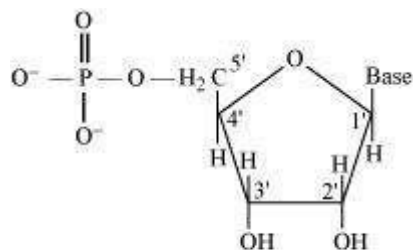

Structure of a nucleotide

Q23 :

The two strands in DNA are not identical but are complementary. Explain.



Answer :

In the helical structure of DNA, the two strands are held together by hydrogen bonds between specific pairs of bases. Cytosine forms hydrogen bond with guanine, while adenine forms hydrogen bond with thymine. As a result, the two strands are complementary to each other.

Q24 :

Write the important structural and functional differences between DNA and RNA.

Answer :

The structural differences between DNA and RNA are as follows:

DNA		RNA	
1.	The sugar moiety in DNA molecules is β -D-2-deoxyribose.	1.	The sugar moiety in RNA molecules is β -D-ribose.
2.	DNA contains thymine (T). It does not contain uracil (U).	2.	RNA contains uracil (U). It does not contain thymine (T).
3.	The helical structure of DNA is double-stranded.	3.	The helical structure of RNA is singlestranded.

The functional differences between DNA and RNA are as follows:

DNA		RNA	
1	DNA is the chemical basis of heredity.	1	RNA is not responsible for heredity.
2	DNA molecules do not synthesise proteins, but transfer coded message for the synthesis of proteins in the cells.	2	Proteins are synthesised by RNA molecules in the cells.

Q25 :

What are the different types of RNA found in the cell?

Answer :

- (i) Messenger RNA (m-RNA)
- (ii) Ribosomal RNA (r-RNA)
- (iii) Transfer RNA (t-RNA)