

**FINAL JEE(Advanced) EXAMINATION - 2019**  
**(Held On Monday 27<sup>th</sup> MAY, 2019)**

**PAPER-1**

**TEST PAPER WITH ANSWER & SOLUTION**

**PART-1 : PHYSICS**

**SECTION-1 : (Maximum Marks : 12)**

- This section contains **FOUR (04)** questions.
- Each question has **FOUR** options. **ONLY ONE** of these four options is the correct answer.
- For each question, choose the option corresponding to the correct answer.
- Answer to each question will be evaluated according to the following marking scheme :
 

*Full Marks* : +3 If **ONLY** the correct option is chosen.  
*Zero Marks* : 0 If none of the options is chosen (i.e. the question is unanswered)  
*Negative Marks* : -1 In all other cases

1. A current carrying wire heats a metal rod. The wire provides a constant power (P) to the rod. The metal rod is enclosed in an insulated container. It is observed that the temperature (T) in the metal rod changes with time (t) as :

$$T(t) = T_0 (1 + \beta t^{1/4})$$

where  $\beta$  is a constant with appropriate dimension while  $T_0$  is a constant with dimension of temperature.

The heat capacity of the metal is :

(1)  $\frac{4P(T(t) - T_0)^3}{\beta^4 T_0^4}$

(2)  $\frac{4P(T(t) - T_0)}{\beta^4 T_0^2}$

(3)  $\frac{4P(T(t) - T_0)^4}{\beta^4 T_0^5}$

(4)  $\frac{4P(T(t) - T_0)^2}{\beta^4 T_0^3}$

**Ans. (1)**

Sol.  $P = \frac{dQ}{dt}$        $T(t) = T_0 (1 + \beta t^{1/4})$

$$\frac{dQ}{dt} = \frac{P}{\left(\frac{dT}{dt}\right)} \Rightarrow S = \frac{P}{\left(\frac{dT}{dt}\right)}$$

$$\frac{dT}{dt} = T_0 \left[ 0 + \beta \frac{1}{4} \cdot t^{-3/4} \right] = \frac{\beta T_0}{4} \cdot t^{-3/4}$$

$$S = \frac{P}{(dT/dt)} = \frac{4P}{\beta T_0} \cdot t^{3/4}$$

$$S = \frac{4P}{\beta} \left[ \frac{t^{3/4}}{T_0} \right]$$

$$\frac{T(t)}{T_0} = (1 + \beta t^{1/4})$$

$$\beta t^{1/4} = \frac{T(t)}{T_0} - 1 = \frac{T(t) - T_0}{T_0}$$

$$t^{3/4} = \left( \frac{T(t) - T_0}{\beta \cdot T_0} \right)^3$$

$$\Rightarrow S = \frac{4P}{T_0 \beta} \left[ \frac{T(t) - T_0}{\beta \cdot T_0} \right]^3 = \frac{4P}{\beta^4 T_0^4} [T(t) - T_0]^3$$

2. A thin spherical insulating shell of radius  $R$  carries a uniformly distributed charge such that the potential at its surface is  $V_0$ . A hole with a small area  $\alpha 4\pi R^2$  ( $\alpha \ll 1$ ) is made on the shell without affecting the rest of the shell. Which one of the following statements is correct ?

(1) The ratio of the potential at the center of the shell to that of the point at  $\frac{1}{2}R$  from center towards

the hole will be  $\frac{1-\alpha}{1-2\alpha}$

(2) The magnitude of electric field at the center of the shell is reduced by  $\frac{\alpha V_0}{2R}$

(3) The magnitude of electric field at a point, located on a line passing through the hole and shell's center

on a distance  $2R$  from the center of the spherical shell will be reduced by  $\frac{\alpha V_0}{2R}$

(4) The potential at the center of the shell is reduced by  $2\alpha V_0$

Ans. (1)

Sol. Let charge on the sphere initially be  $Q$ .

$$\therefore \frac{kQ}{R} = V_0$$

and charge removed =  $\alpha Q$

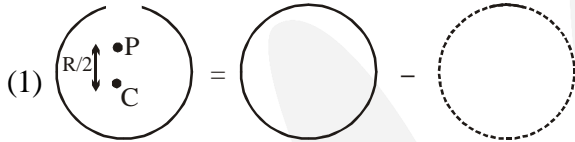

$$\text{and } V_p = \frac{kQ}{R} - \frac{2k\alpha Q}{R} = \frac{kQ}{R}(1-2\alpha)$$

$$V_c = \frac{kQ(1-\alpha)}{R}$$

$$\therefore \frac{V_c}{V_p} = \frac{1-\alpha}{1-2\alpha}$$

(2)  $(E_c)_{\text{initial}} = \text{zero}$

$$(E_c)_{\text{final}} = \frac{k\alpha Q}{R^2}$$

$\Rightarrow$  Electric field increases

(3)  $(E_p)_{\text{initial}} = \frac{kQ}{4R^2}$

$$(E_p)_{\text{final}} = \frac{kQ}{4R^2} - \frac{k\alpha Q}{R^2}$$

$$\Delta E_p = \frac{kQ}{4R^2} - \frac{kQ}{4R^2} + \frac{k\alpha Q}{R^2} = \frac{k\alpha Q}{R^2} = \frac{V_0 \alpha}{R}$$

(4)  $(V_c)_{\text{initial}} = \frac{kQ}{R}$

$$(V_c)_{\text{final}} = \frac{kQ(1-\alpha)}{R}$$

$$\Delta V_c = \frac{kQ}{R}(\alpha) = \alpha V_0$$

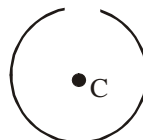
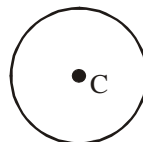
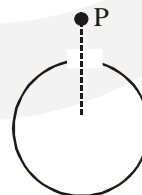
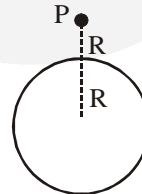
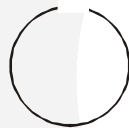

3. Consider a spherical gaseous cloud of mass density  $\rho(r)$  in free space where  $r$  is the radial distance from its center. The gaseous cloud is made of particles of equal mass  $m$  moving in circular orbits about the common center with the same kinetic energy  $K$ . The force acting on the particles is their mutual gravitational force. If  $\rho(r)$  is constant in time, the particle number density  $n(r) = \rho(r)/m$  is :  
[G is universal gravitational constant]

- (1)  $\frac{K}{\pi r^2 m^2 G}$                                   (2)  $\frac{K}{6\pi r^2 m^2 G}$   
(3)  $\frac{3K}{\pi r^2 m^2 G}$                                   (4)  $\frac{K}{2\pi r^2 m^2 G}$

**Ans. (4)**

**Sol.** Let total mass included in a sphere of radius  $r$  be  $M$ .

For a particle of mass  $m$ ,

$$\frac{GMm}{r^2} = \frac{mv^2}{r}$$

$$\Rightarrow \frac{GMm}{r} = 2K \quad \Rightarrow \quad M = \frac{2Kr}{Gm}$$

$$\therefore dM = \frac{2Kdr}{Gm}$$

$$\Rightarrow (4\pi r^2 dr)\rho = \frac{2Kdr}{Gm}$$

$$\Rightarrow \rho = \frac{K}{2\pi r^2 Gm}$$

$$\therefore n = \frac{\rho}{m} = \frac{K}{2\pi r^2 m^2 G}$$

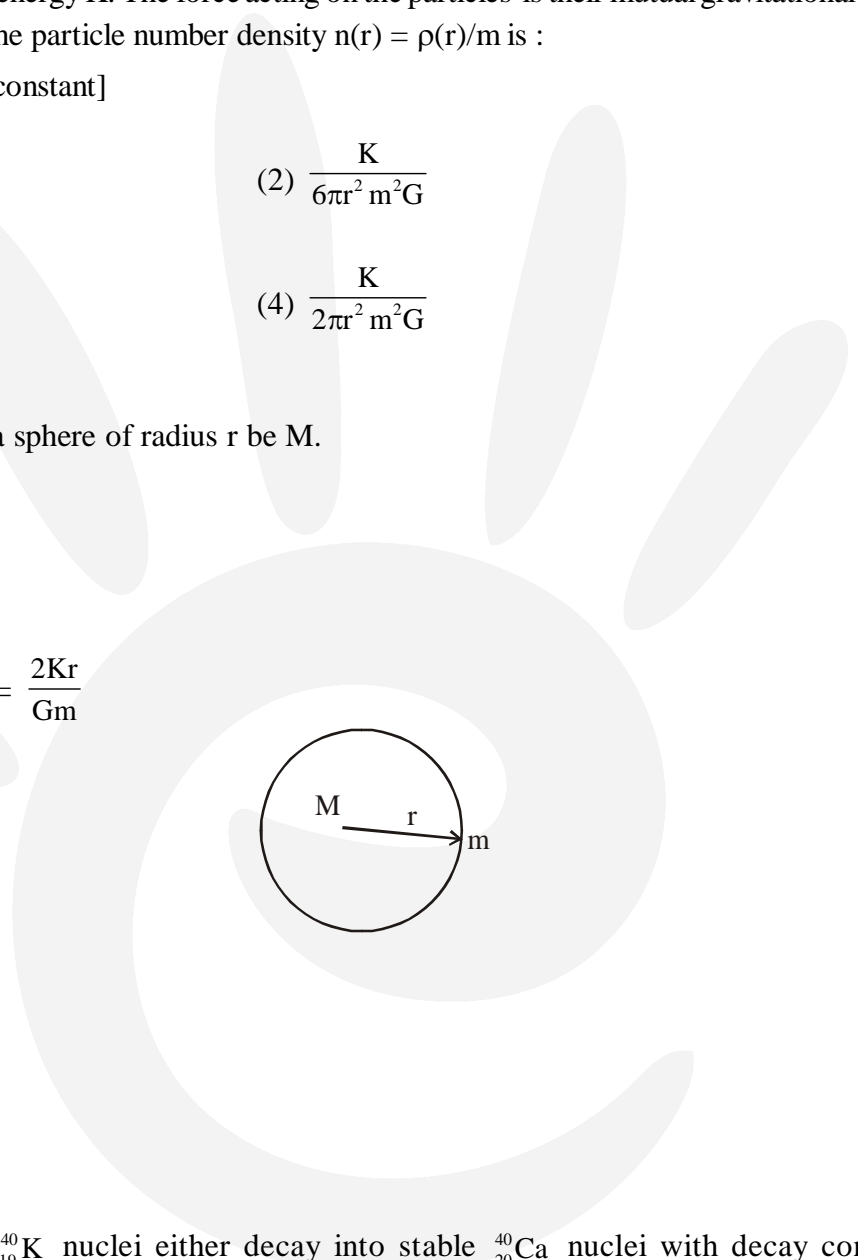

4. In a radioactive sample,  ${}^{40}_{19}\text{K}$  nuclei either decay into stable  ${}^{40}_{20}\text{Ca}$  nuclei with decay constant  $4.5 \times 10^{-10}$  per year or into stable  ${}^{40}_{18}\text{Ar}$  nuclei with decay constant  $0.5 \times 10^{-10}$  per year. Given that in this sample all the stable  ${}^{40}_{20}\text{Ca}$  and  ${}^{40}_{18}\text{Ar}$  nuclei are produced by the  ${}^{40}_{19}\text{K}$  nuclei only. In time  $t \times 10^9$  years, if the ratio of the sum of stable  ${}^{40}_{20}\text{Ca}$  and  ${}^{40}_{18}\text{Ar}$  nuclei to the radioactive  ${}^{40}_{19}\text{K}$  nuclei is 99, the value of  $t$  will be : [Given  $\ln 10 = 2.3$ ]  
(1) 9.2    (2) 1.15    (3) 4.6    (4) 2.3

**Ans. (1)**

Sol. Parallel radioactive decay

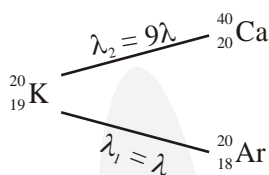

$$\lambda = \lambda_1 + \lambda_2 = 5 \times 10^{-10} \text{ per year}$$

$$N = N_0 e^{-\lambda t}$$

$$N_0 - N = N_{\text{stable}}$$

$$N = N_{\text{radioactive}}$$

$$\frac{N_0}{N} - 1 = 99$$

$$\frac{N_0}{N} = 100$$

$$\frac{N}{N_0} = e^{-\lambda t} = \frac{1}{100}$$

$$\Rightarrow \lambda t = 2 \ln 10$$

$$= 4.6$$

$$t = 9.2 \times 10^9 \text{ years}$$

### SECTION-2 : (Maximum Marks: 32)

- This section contains **EIGHT (08)** questions.
- Each question has **FOUR** options. **ONE OR MORE THAN ONE** of these four option(s) is (are) correct answer(s).
- For each question, choose the option(s) corresponding to (all ) the correct answer(s)
- Answer to each question will be evaluated according to the following marking scheme:
 

<i>Full Marks</i>	: +4	If only (all) the correct option(s) is (are) chosen.
<i>Partial Marks</i>	: +3	If all the four options are correct but <b>ONLY</b> three options are chosen.
<i>Partial Marks</i>	: +2	If three or more options are correct but <b>ONLY</b> two options are chosen and both of which are correct.
<i>Partial Marks</i>	: +1	If two or more options are correct but <b>ONLY</b> one option is chosen and it is a correct option.
<i>Zero Marks</i>	: 0	If none of the options is chosen (i.e. the question is unanswered).
<i>Negative Marks</i>	: -1	In all other cases.
- For example, in a question, if (A), (B) and (D) are the **ONLY** three options corresponding to correct answers, then
  - choosing **ONLY** (A), (B) and (D) will get +4 marks;
  - choosing **ONLY** (A) and (B) will get +2 marks;
  - choosing **ONLY** (A) and (D) will get +2 marks;
  - choosing **ONLY** (B) and (D) will get +2 marks;
  - choosing **ONLY** (A) will get +1 marks;
  - choosing **ONLY** (B) will get +1 marks;
  - choosing **ONLY** (D) will get +1 marks;
  - choosing no option (i.e. the question is unanswered) will get 0 marks; and
  - choosing any other combination of options will get -1 mark.

1. One mole of a monoatomic ideal gas goes through a thermodynamic cycle, as shown in the volume versus temperature (V-T) diagram. The correct statement(s) is/are :  
[R is the gas constant]

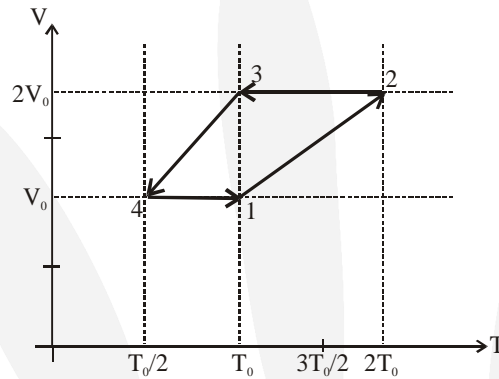

- (1) Work done in this thermodynamic cycle (1→2→3→4→1) is  $|W| = \frac{1}{2}RT_0$
- (2) The ratio of heat transfer during processes 1→2 and 2→3 is  $\left| \frac{Q_{1 \rightarrow 2}}{Q_{2 \rightarrow 3}} \right| = \frac{5}{3}$
- (3) The above thermodynamic cycle exhibits only isochoric and adiabatic processes.
- (4) The ratio of heat transfer during processes 1→2 and 3→4 is  $\left| \frac{Q_{1 \rightarrow 2}}{Q_{3 \rightarrow 4}} \right| = \frac{1}{2}$

**Ans. (1,2)**

**Sol.** From graph

Process 1 → 2 is isobaric with  $P = \frac{RT_0}{V_0}$

Process 2 → 3 is isochoric with  $V = 2V_0$

Process 3 → 4 is isobaric with  $P = \frac{RT_0}{2V_0}$

Process 4 → 1 is isochoric with  $V = V_0$

$$\text{Work in cycle} = \frac{RT_0}{V_0} \cdot V_0 - \frac{RT_0}{2V_0} \cdot V_0 = \frac{RT_0}{2}$$

$$Q_{1-2} = nC_p \Delta T = n \cdot \frac{5R}{2} \cdot T_0$$

$$Q_{2-3} = nC_v \Delta T = n \cdot \frac{3R}{2} \cdot T_0$$

$$\therefore \left| \frac{Q_{1-2}}{Q_{2-3}} \right| = \frac{5}{3}$$

$$Q_{3-4} = nC_p \Delta T = n \cdot \frac{5R}{2} \cdot \frac{T_0}{2}$$

$$\therefore \left| \frac{Q_{1-2}}{Q_{3-4}} \right| = 2$$

Ans. 1, 2

2. In the circuit shown, initially there is no charge on capacitors and keys  $S_1$  and  $S_2$  are open. The values of the capacitors are  $C_1 = 10 \mu\text{F}$ ,  $C_2 = 30 \mu\text{F}$  and  $C_3 = C_4 = 80 \mu\text{F}$ .

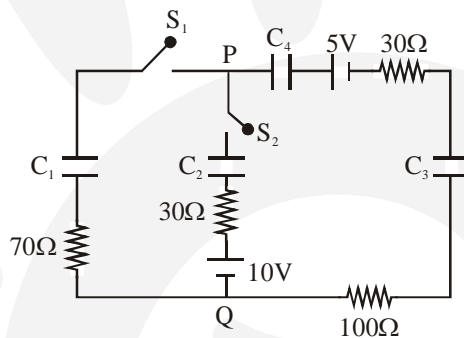

Which of the statement(s) is/are correct ?

- (1) The keys  $S_1$  is kept closed for long time such that capacitors are fully charged. Now key  $S_2$  is closed, at this time, the instantaneous current across  $30 \Omega$  resistor (between points P and Q) will be  $0.2 \text{ A}$  (round off to  $1^{\text{st}}$  decimal place).
- (2) If key  $S_1$  is kept closed for long time such that capacitors are fully charged, the voltage difference between points P and Q will be  $10 \text{ V}$ .
- (3) At time  $t = 0$ , the key  $S_1$  is closed, the instantaneous current in the closed circuit will be  $25 \text{ mA}$ .
- (4) If key  $S_1$  is kept closed for long time such that capacitors are fully charged, the voltage across the capacitors  $C_1$  will be  $4 \text{ V}$ .

Ans. (3,4)

Sol.

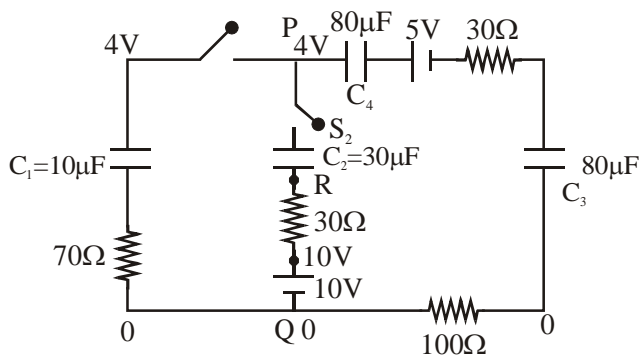

(1) at  $t = 0$ , capacitor  $C_1$  acts as a battery of 4V,  $C_4$  &  $C_3$  of  $\frac{1}{2}V$  each,  $C_2$  is shorted

Circuit is

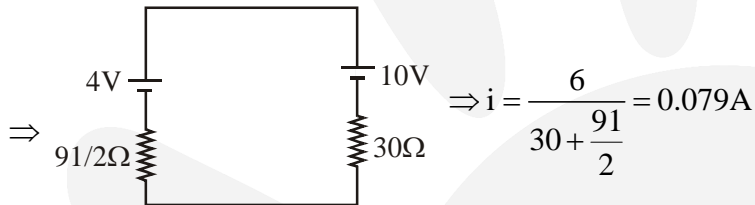
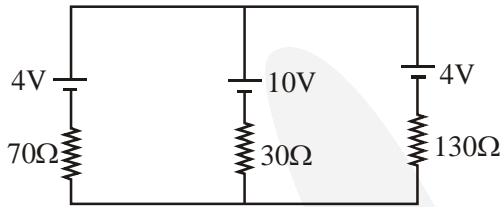

(2) and (4)

At steady state,

When capacitor is fully charged it behave as open circuit and current through it zero.

Hence, Charge on each capacitor is same.

$$Q = C_{eq} V$$

$$= (8 \mu F) \times 5$$

$$Q = 40 \mu C$$

Now,

$$V_P - \frac{40}{10} = V_Q$$

$$\boxed{V_P - V_Q = 4V}$$

(3) At  $t = 0$ ,  $S_1$  is closed, capacitor act as short circuit.

$$i = \frac{V}{R_{eq}} = \frac{5}{200} = 25mA$$

Ans. (3, 4)



3. A thin convex lens is made of two materials with refractive indices  $n_1$  and  $n_2$ , as shown in figure. The radius of curvature of the left and right spherical surfaces are equal.  $f$  is the focal length of the lens when  $n_1 = n_2 = n$ . The focal length is  $f + \Delta f$  when  $n_1 = n$  and  $n_2 = n + \Delta n$ . Assuming  $\Delta n \ll (n-1)$  and  $1 < n < 2$ , the correct statement(s) is/are :

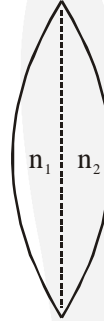

- (1) The relation between  $\frac{\Delta f}{f}$  and  $\frac{\Delta n}{n}$  remains unchanged if both the convex surfaces are replaced by concave surfaces of the same radius of curvature.
- (2)  $\left| \frac{\Delta f}{f} \right| < \left| \frac{\Delta n}{n} \right|$
- (3) For  $n = 1.5$ ,  $\Delta n = 10^{-3}$  and  $f = 20$  cm, the value of  $|\Delta f|$  will be 0.02 cm (round off to 2<sup>nd</sup> decimal place)
- (4) If  $\frac{\Delta n}{n} < 0$  then  $\frac{\Delta f}{f} > 0$

Ans. (1,3,4)

Sol. When  $n_1 = n_2 = n$

$$\frac{1}{f} = (n-1) \times \frac{2}{R}$$

So  $f = \frac{R}{2(n-1)}$  .....(1)

2<sup>nd</sup> case :

$$\frac{1}{f_1} = \frac{n-1}{R}$$

$$\frac{1}{f_2} = \frac{(n+\Delta n)-1}{R}$$

$$\frac{1}{f_{eq}} = \frac{1}{f + \Delta f} = \left( \frac{n-1}{R} \right) + \frac{(n+\Delta n)-1}{R} = \frac{2(n-1) + \Delta n}{R}$$

$$\Delta f = \left( \frac{R}{2(n-1) + \Delta n} \right) - \left( \frac{R}{2(n-1)} \right)$$

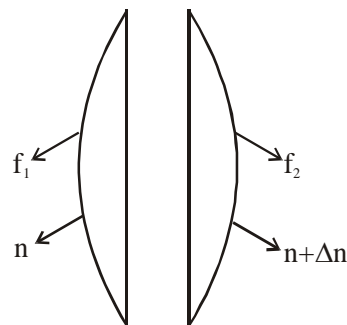

$$= \frac{R}{2} \left[ \frac{(n-1) - (n-1+\Delta n)}{(n-1+\Delta n)(n-1)} \right] = \frac{-\Delta n}{(n-1)^2} \times \frac{R}{2}$$

$$\frac{\Delta f}{f} = -\frac{\Delta n}{2(n-1)} \quad \dots(2)$$

(1) Relation between  $\frac{\Delta f}{f}$  and  $\frac{\Delta n}{n}$  is independent of R so (1) is correct.

(2)  $2n - 2 < n$  because  $n < 2$

$$\Rightarrow \frac{\Delta f}{f} = \frac{1}{2} \left| \frac{\Delta n}{n-1} \right| > \frac{\Delta n}{n}$$

So  $\frac{\Delta f}{f} > \left| \frac{\Delta n}{n} \right|$  So (2) is wrong

$$(3) |\Delta f| = \frac{f\Delta n}{(n-1)} = \frac{(20 \times 10^{-3})}{1.5-1} = 40 \times 10^{-3} = 0.04$$

So (3) is wrong

(4) If  $\frac{\Delta n}{n} < 0$  then  $\frac{\Delta f}{f} > 0$  from equation (2)

4. Let us consider a system of units in which mass and angular momentum are dimensionless. If length has dimension of L, which of the following statement (s) is/are correct ?

(1) The dimension of force is  $L^{-3}$

(2) The dimension of energy is  $L^{-2}$

(3) The dimension of power is  $L^{-5}$

(4) The dimension of linear momentum is  $L^{-1}$

**Ans. (1,2,4)**

**Sol.** Mass =  $M^0 L^0 T^0$

$$M V r = M^0 L^0 T^0$$

$$M^0 \frac{L^1}{T^1} \cdot L^1 = M^0 L^0 T^0$$

$$L^2 = T^1 \quad \dots\dots\dots(1)$$

$$\text{Force} = M^1 L^1 T^{-2} \quad (\text{in SI})$$

$$= M^0 L^1 L^{-4} \quad (\text{In new system from equation (1)})$$

$$= L^{-3}$$

$$\text{Energy} = M^1 L^2 T^{-2} \quad (\text{In SI})$$

$$= M^0 L^2 L^{-4} \quad (\text{In new system from equation (1)})$$

$$= L^{-2}$$

$$\text{Power} = \frac{\text{Energy}}{\text{Time}}$$

$$= M^1 L^2 T^{-3} \quad (\text{in SI})$$

$$= M^0 L^2 L^{-6} \quad (\text{In new system from equation (1)})$$

$$= L^{-4}$$

$$\text{Linear momentum} = M^1 L^1 T^{-1} \quad (\text{in SI})$$

$$= M^0 L^1 L^{-2} \quad (\text{In new system from equation (1)})$$

$$= L^{-1}$$

Ans. (1, 2, 4)

5. A cylindrical capillary tube of 0.2 mm radius is made by joining two capillaries T1 and T2 of different materials having water contact angles of  $0^\circ$  and  $60^\circ$ , respectively. The capillary tube is dipped vertically in water in two different configurations, case I and II as shown in figure. Which of the following option(s) is(are) correct ?

(Surface tension of water = 0.075 N/m, density of water =  $1000 \text{ kg/m}^3$ , take  $g = 10 \text{ m/s}^2$ )

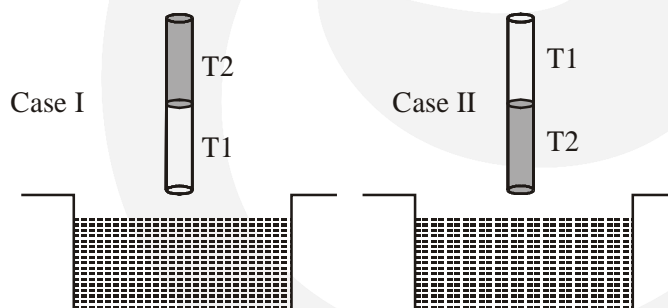

- (1) The correction in the height of water column raised in the tube, due to weight of water contained in the meniscus, will be different for both cases.
- (2) For case I, if the capillary joint is 5 cm above the water surface, the height of water column raised in the tube will be more than 8.75 cm. (Neglect the weight of the water in the meniscus)
- (3) For case I, if the joint is kept at 8 cm above the water surface, the height of water column in the tube will be 7.5 cm. (Neglect the weight of the water in the meniscus)
- (4) For case II, if the capillary joint is 5 cm above the water surface, the height of water column raised in the tube will be 3.75 cm. (Neglect the weight of the water in the meniscus)

Ans. (1,3,4)

$$\text{Sol. } h = \frac{2T \cos \theta}{\rho g R} \quad ; \quad h_1 = \frac{2 \times 0.075 \times \cos 0^\circ}{1000 \times 10 \times 0.2 \times 10^{-3}}$$

$\Rightarrow h_1 = 75 \text{ mm}$  (in T1) [If we assume entire tube of T1]

$\Rightarrow h_2 = \frac{2 \times 0.075 \times \cos 60^\circ}{1000 \times 10 \times 0.2 \times 10^{-3}} = 37.5 \text{ mm}$  (in T2) [If we assume entire tube of T2]

Option (1) : Since contact angles are different so correction in the height of water column raised in the tube will be different in both the cases, so option (1) is correct

Option (2) : If joint is 5 cm is above water surface, then lets say water crosses the joint by height h, then:

$$\Rightarrow P_0 - \frac{2T}{r} + \rho gh + \rho g \times 5 \times 10^{-2} = P_0$$

$$\Rightarrow \cos \theta = \frac{R}{r}, r = \frac{R}{\cos \theta}$$

$$\Rightarrow \rho g(h + 5 \times 10^{-2}) = \frac{2T \cos \theta}{R}$$

$$\Rightarrow h = \frac{2 \times 0.075 \times \cos 60}{0.2 \times 10^{-3} \times 1000 \times 10} - 5 \times 10^{-2}$$

$\Rightarrow h = -ve$ , not possible, so liquid will not cross the interface, but angle of contact at the interface will change, to balance the pressure,

So option (2) is wrong.

Option (3) : If interface is 8 cm above water then water will not even reach the interface, and water will rise till 7.5 cm only in T1, so option (3) is right.

Option (4) : If interface is 5 cm above the water in vessel, then water in capillary will not even reach the interface. Water will reach only till 3.75 cm, so option (4) is right.

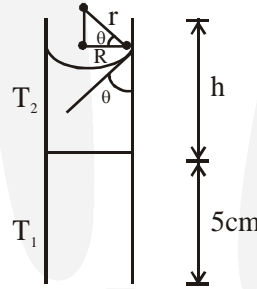

6. Two identical moving coil galvanometer have  $10 \Omega$  resistance and full scale deflection at  $2 \mu\text{A}$  current. One of them is converted into a voltmeter of  $100 \text{ mV}$  full scale reading and the other into an Ammeter of  $1 \text{ mA}$  full scale current using appropriate resistors. These are then used to measure the voltage and current in the Ohm's law experiment with  $R = 1000 \Omega$  resistor by using an ideal cell. Which of the following statement(s) is/are correct ?

- (1) The measured value of  $R$  will be  $978 \Omega < R < 982 \Omega$ .
- (2) The resistance of the Voltmeter will be  $100 \text{ k}\Omega$ .
- (3) The resistance of the Ammeter will be  $0.02 \Omega$  ( round off to 2<sup>nd</sup> decimal place)
- (4) If the ideal cell is replaced by a cell having internal resistance of  $5 \Omega$  then the measured value of  $R$  will be more than  $1000 \Omega$ .

Ans. (1,3)

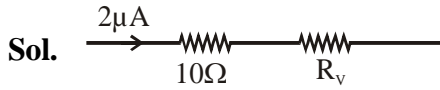

$$0.1 = 2 \times 10^{-6} (10 + R_v)$$

$$\therefore R_v = 49990 \Omega$$

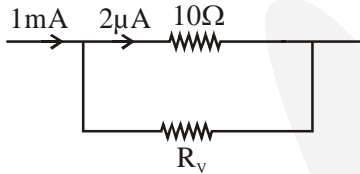

$$2 \times 10^{-6} \times 10 = 10^{-3} R_A \therefore R_A = 0.02 \Omega$$

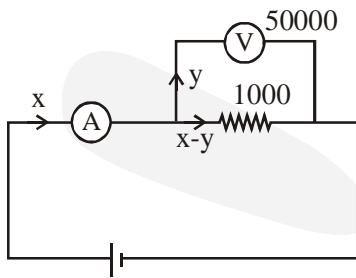

$$y \cdot 50000 = (x - y) \cdot 1000$$

$$\therefore 51y = x$$

$$\text{Reading} = \frac{y \cdot 50000}{x} \approx 980$$

7. A charged shell of radius  $R$  carries a total charge  $Q$ . Given  $\Phi$  as the flux of electric field through a closed cylindrical surface of height  $h$ , radius  $r$  and with its center same as that of the shell. Here, center of the cylinder is a point on the axis of the cylinder which is equidistant from its top and bottom surfaces. Which of the following option(s) is/are correct ? [ $\epsilon_0$  is the permittivity of free space]

(1) If  $h > 2R$  and  $r > R$  then  $\Phi = \frac{Q}{\epsilon_0}$       (2) If  $h < \frac{8R}{5}$  and  $r = \frac{3R}{5}$  then  $\Phi = 0$

(3) If  $h > 2R$  and  $r = \frac{4R}{5}$  then  $\Phi = \frac{Q}{5\epsilon_0}$       (4) If  $h > 2R$  and  $r = \frac{3R}{5}$  then  $\Phi = \frac{Q}{5\epsilon_0}$

Ans. (1,2,4)

Sol. For option (1), cylinder encloses the shell, thus option is correct

For option (2),

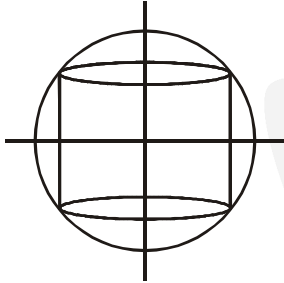

cylinder perfectly enclosed by shell,

thus  $\phi = 0$ , so option is correct.

For option (3)

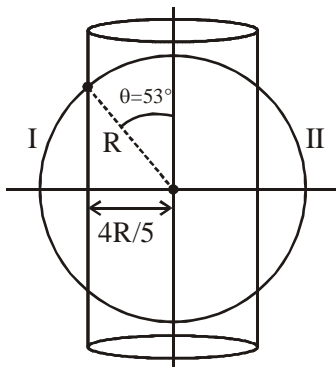

$$\phi = \frac{2 \times Q}{2 \epsilon_0} (1 - \cos 53^\circ) = \frac{2Q}{5 \epsilon_0}$$

For option (4) :

$$\text{Flux enclosed by cylinder} = \phi = \frac{2Q}{2 \epsilon_0} (1 - \cos 37^\circ) = \frac{Q}{5 \epsilon_0}$$

8. A conducting wire of parabolic shape, initially  $y = x^2$ , is moving with velocity  $\vec{V} = V_0 \hat{i}$  in a non-uniform

magnetic field  $\vec{B} = B_0 \left( 1 + \left( \frac{y}{L} \right)^\beta \right) \hat{k}$ , as shown in figure. If  $V_0, B_0, L$  and  $\beta$  are positive constants and

$\Delta\phi$  is the potential difference developed between the ends of the wire, then the correct statement(s) is/are:

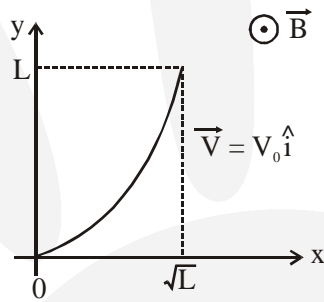

- (1)  $|\Delta\phi|$  remains the same if the parabolic wire is replaced by a straight wire,  $y = x$  initially, of length  $\sqrt{2}L$
- (2)  $|\Delta\phi|$  is proportional to the length of the wire projected on the y-axis.
- (3)  $|\Delta\phi| = \frac{1}{2} B_0 V_0 L$  for  $\beta = 0$
- (4)  $|\Delta\phi| = \frac{4}{3} B_0 V_0 L$  for  $\beta = 2$

Ans. (1,2,4)

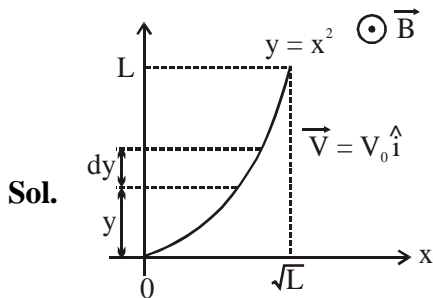

$$y = x^2$$

$$\mathbf{B} = B_0 \left[ 1 + \left( \frac{y}{L} \right)^\beta \right] \hat{\mathbf{k}}$$

$$\int d\phi = \int_0^L V_0 B_0 \left( 1 + \frac{y^\beta}{L^\beta} \right) \cdot dy$$

$$\Delta\phi = V_0 B_0 \left[ L + \frac{L^{\beta+1}}{(\beta+1)L^\beta} \right]$$

$$\Delta\phi = V_0 B_0 \left[ L + \frac{L}{\beta+1} \right]$$

$$\therefore |\Delta\phi| = B_0 V_0 \left( 1 + \frac{1}{\beta+1} \right) \cdot L$$

$|\Delta\phi| \propto L \therefore$  option '2' is also correct

If  $\beta = 0$

$$\Delta\phi = V_0 B_0 [L + L]$$

$\Delta\phi = 2V_0 B_0 L \Rightarrow$  option (3) is incorrect

If  $\beta = 2$

$$\Delta\phi = V_0 B_0 \left[ L + \frac{L}{3} \right]$$

$$\Delta\phi = \frac{4}{3} V_0 B_0 L \text{ option (4) is correct}$$

$\Delta\phi$  will be same if the wire is replaced by the straight wire of length  $\sqrt{2}L$  and  $y = x$

$\therefore$  range of  $y$  remains same

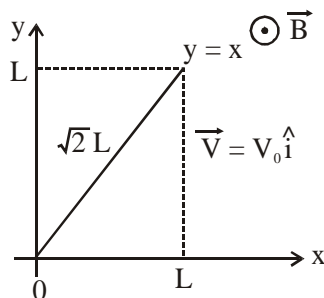

$\therefore$  option 1 is correct.



**SECTION-3 : (Maximum Marks: 18)**

- This section contains **SIX (06)** questions. The answer to each question is a **NUMERICAL VALUE**.
- For each question, enter the correct numerical value of the answer using the mouse and the on-screen virtual numeric keypad in the place designated to enter the answer. If the numerical value has more than two decimal places, **truncate/round-off** the value to **TWO** decimal places.
- Answer to each question will be evaluated according to the following marking scheme:

*Full Marks* : +3 If **ONLY** the correct numerical value is entered.

*Zero Marks* : 0 In all other cases.

1. A block of weight 100 N is suspended by copper and steel wires of same cross sectional area  $0.5 \text{ cm}^2$  and, length  $\sqrt{3} \text{ m}$  and  $1 \text{ m}$ , respectively. Their other ends are fixed on a ceiling as shown in figure. The angles subtended by copper and steel wires with ceiling are  $30^\circ$  and  $60^\circ$ , respectively. If elongation in copper wire is  $(\Delta l_C)$  and elongation in steel wire is  $(\Delta l_S)$ , then the ratio  $\frac{\Delta l_C}{\Delta l_S}$  is \_\_\_\_\_.

[Young's modulus for copper and steel are  $1 \times 10^{11} \text{ N/m}^2$  and  $2 \times 10^{11} \text{ N/m}^2$  respectively]

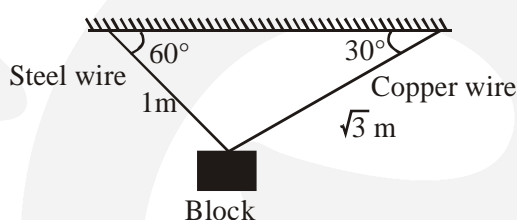

**Ans. (2.00)**

**Sol.** Let  $T_S$  = tension in steel wire

$T_C$  = Tension in copper wire

in x direction

$$T_C \cos 30^\circ = T_S \cos 60^\circ$$

$$T_C \times \frac{\sqrt{3}}{2} = T_S \times \frac{1}{2}$$

$$\sqrt{3} T_C = T_S \dots (i)$$

in y direction

$$T_C \sin 30^\circ + T_S \sin 60^\circ = 100$$

$$\frac{T_C}{2} + \frac{T_S \sqrt{3}}{2} = 100 \dots (ii)$$

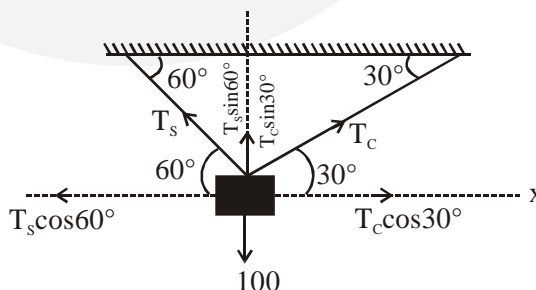

Solving equation (i) & (ii)

$$T_C = 50 \text{ N}$$

$$T_S = 50\sqrt{3} \text{ N}$$

We know

$$\Delta L = \frac{FL}{AY}$$

$$= \frac{\Delta L_C}{\Delta L_S} = \frac{T_C L_C}{A_C Y_C} \times \frac{A_S Y_S}{T_S L_S}$$

On solving above equation

$$\frac{\Delta L_C}{\Delta L_S} = 2$$

Ans. 2.00

2. A planar structure of length  $L$  and width  $W$  is made of two different optical media of refractive indices  $n_1 = 1.5$  and  $n_2 = 1.44$  as shown in figure. If  $L \gg W$ , a ray entering from end AB will emerge from end CD only if the total internal reflection condition is met inside the structure. For  $L = 9.6 \text{ m}$ , if the incident angle  $\theta$  is varied, the maximum time taken by a ray to exit the plane CD is  $t \times 10^{-9} \text{ s}$ , where  $t$  is \_\_\_\_\_. [Speed of light  $c = 3 \times 10^8 \text{ m/s}$ ]

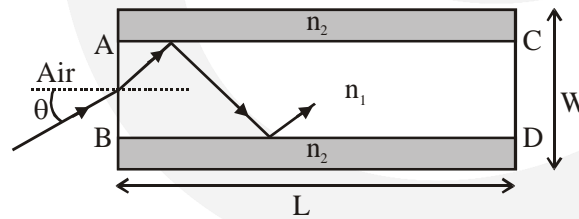

Ans. (50.00)

Sol. For maximum time the ray of light must undergo TIR at all surfaces at minimum angle i.e.  $\theta_c$

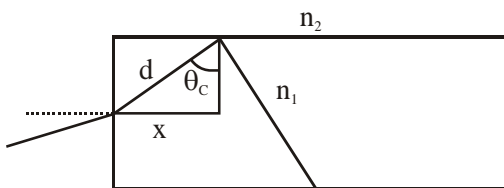

For TIR  $n_1 \sin \theta_c = n_2$

$$\sin \theta_C = \frac{1.44}{1.5}$$

In above  $\Delta$   $\sin \theta_C = \frac{x}{d}$

$$d = \frac{x}{\sin \theta_C}$$

Similarly  $D = \frac{L}{\sin \theta_C}$

where  $L$  = length of tube,  $D$  = length of path of light

Time taken by light

$$t = \frac{D}{C} = \frac{L / \sin \theta_C}{2 \times 10^8}$$

$$t = 50 \times 10^{-9} \text{ s}$$

3. A particle is moved along a path AB-BC-CD-DE-EF-FA, as shown in figure, in presence of a force  $\vec{F} = (\alpha y \hat{i} + 2\alpha x \hat{j}) \text{ N}$ , where  $x$  and  $y$  are in meter and  $\alpha = -1 \text{ N/m}^{-1}$ . The work done on the particle by this force  $\vec{F}$  will be \_\_\_\_\_ Joule.

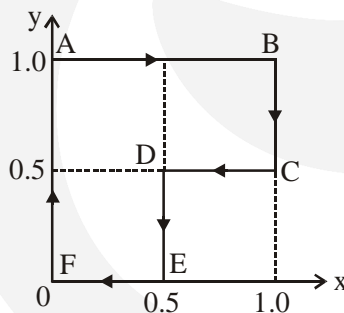

Ans. (0.75)

Sol.  $F = (\alpha y \hat{i} + 2\alpha x \hat{j})$

$$W_{AB} = (-1 \hat{i}) \cdot (1 \hat{i}) = -1 \text{ J}$$

$$\left[ \begin{array}{l} \vec{F} = -1 \hat{i} + 2\alpha x \hat{j} \\ \vec{S} = 1 \hat{i} \end{array} \right]$$

Similarly,

$$W_{BC} = 1 \text{ J}$$

$$W_{CD} = 0.25J$$

$$W_{DE} = 0.5 J$$

$$W_{EF} = W_{FA} = 0 J$$

$$\therefore \text{New work in cycle} = 0.75 J$$

4. A parallel plate capacitor of capacitance  $C$  has spacing  $d$  between two plates having area  $A$ . The region between the plates is filled with  $N$  dielectric layers, parallel to its plates, each with thickness  $\delta = \frac{d}{N}$ . The dielectric constant of the  $m^{\text{th}}$  layer is  $K_m = K \left( 1 + \frac{m}{N} \right)$ . For a very large  $N (> 10^3)$ , the capacitance  $C$  is  $\alpha \left( \frac{K \epsilon_0 A}{d \ln 2} \right)$ . The value of  $\alpha$  will be \_\_\_\_\_.

[ $\epsilon_0$  is the permittivity of free space]

**Ans. (1.00)**

**Sol.**

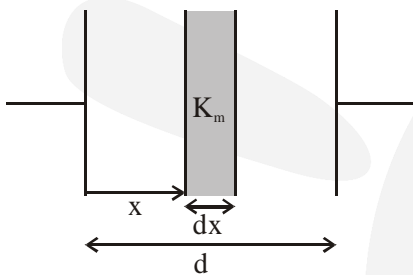

$$\delta = dx = \frac{d}{N} \quad \& \quad \frac{m}{N} = \frac{x}{d}$$

$$K_m = K \left( 1 + \frac{m}{N} \right)$$

$$\Rightarrow K_m = K \left( 1 + \frac{x}{d} \right)$$

$$C' = \frac{K_m A \epsilon_0}{dx}$$

$$\frac{1}{C_{eq}} = \int_0^d \frac{dx}{K_m A \epsilon_0} = \frac{1}{KA \epsilon_0} \int_0^d \frac{dx}{\left( 1 + \frac{x}{d} \right)}$$

$$\Rightarrow \frac{1}{C_{eq}} = \frac{d}{KA \epsilon_0} \left[ \ln \left( 1 + \frac{x}{d} \right) \right]_0^d$$

$$\Rightarrow \frac{1}{C_{eq}} = \frac{d}{KA \epsilon_0} [\ln 2 - \ln(1)]$$

$$\Rightarrow C_{eq} = \frac{KA \epsilon_0}{d \ln 2} \Rightarrow \alpha = 1$$

5. A train S1, moving with a uniform velocity of 108 km/h, approaches another train S2 standing on a platform. An observer O moves with a uniform velocity of 36 km/h towards S2, as shown in figure. Both the trains are blowing whistles of same frequency 120 Hz. When O is 600 m away from S2 and distance between S1 and S2 is 800 m, the number of beats heard by O is \_\_\_\_.
- [Speed of the sound = 330 m/s]

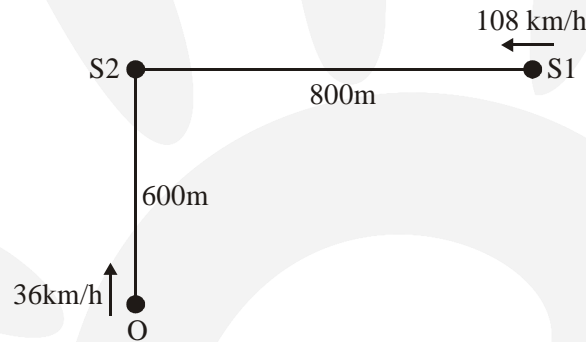

Ans. (8.12 to 8.13)

Sol. Frequency observed by O from S<sub>2</sub>

$$f_2 = \frac{330 + 10}{330} \times 120 = \frac{340}{330} \times 120 = 123.63 \text{ Hz}$$

frequency observed by O from S<sub>1</sub>

$$f_1 = \frac{330 + 6}{330 - 24} \times 120 = \frac{336}{306} \times 120 \approx 131.76 \text{ Hz}$$

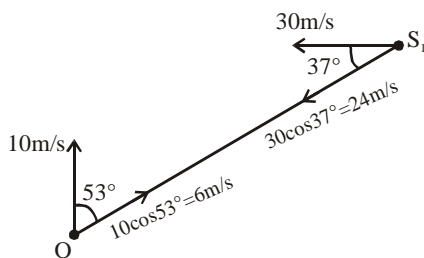

$$\text{beat frequency} = 131.76 - 123.63 = 8.128 \approx 8.12 \text{ to } 8.13 \text{ Hz}$$

6. A liquid at  $30^{\circ}\text{C}$  is poured very slowly into a Calorimeter that is at temperature of  $110^{\circ}\text{C}$ . The boiling temperature of the liquid is  $80^{\circ}\text{C}$ . It is found that the first 5 gm of the liquid completely evaporates. After pouring another 80 gm of the liquid the equilibrium temperature is found to be  $50^{\circ}\text{C}$ . The ratio of the Latent heat of the liquid to its specific heat will be \_\_\_\_\_  $^{\circ}\text{C}$ .

[Neglect the heat exchange with surrounding]

**Ans. (270.00)**

**Sol.** Let  $m$  = mass of calorimeter,  
 $x$  = specific heat of calorimeter  
 $s$  = specific heat of liquid  
 $L$  = latent heat of liquid

First 5 g of liquid at  $30^{\circ}$  is poured to calorimeter at  $110^{\circ}\text{C}$

$$\therefore m \times x \times (110 - 80) = 5 \times s \times (80 - 30) + 5 L$$

$$\Rightarrow mx \times 30 = 250 s + 5 L \dots (i)$$

Now, 80 g of liquid at  $30^{\circ}$  is poured into calorimeter at  $80^{\circ}\text{C}$ , the equilibrium temperature reaches to  $50^{\circ}\text{C}$ .

$$\therefore m \times x \times (80 - 30) = 80 \times s \times (50 - 30)$$

$$\Rightarrow mx \times 30 = 1600 s \dots (ii)$$

From (i) & (ii)

$$250 s + 5 L = 1600 s \Rightarrow 5L = 1350 s$$

$$\Rightarrow \frac{L}{s} = 270$$