



**FINAL JEE–MAIN EXAMINATION – JANUARY, 2023**  
**Held On Wednesday 25th January, 2023**  
**TIME : 3 : 00 PM to 6 : 00 PM**

**SECTION-A**

1. Match List I with List II

List		List II	
A.	Young's Modulus (Y)	I.	$[ML^{-1}T^{-1}]$
B.	Co-efficient of Viscosity ( $\eta$ )	II.	$[ML^2T^{-1}]$
C.	Planck's Constant (h)	III.	$[ML^{-1}T^{-2}]$
D.	Work Function ( $\phi$ )	IV.	$[ML^2T^{-2}]$

Choose the correct answer from the options given below:

- (1) A-II, B-III, C-IV, D-I
- (2) A-III, B-I, C-II, D-IV
- (3) A-I, B-III, C-IV, D-II
- (4) A-I, B-II, C-III, D-IV

**Official Ans. by NTA (2)**

**Ans. (2)**

**Sol.**  $Y = \frac{\text{Stress}}{\text{Strain}} = \frac{F/A}{\Delta\ell/\ell} = \frac{[MLT^{-2}]}{[L^2]} = [ML^{-1}T^{-2}]$

$$F = 6\pi\eta rv \Rightarrow \eta = \frac{F}{6\pi rv}$$

$$[\eta] = \frac{[MLT^{-2}]}{[L][LT^{-1}]} = [ML^{-1}T^{-1}]$$

$$E = hv \Rightarrow h = \frac{E}{v} = \frac{[ML^2T^{-2}]}{[T^{-1}]} = [ML^2T^{-1}]$$

Work function has same dimension as that of energy, so  $[\phi] = [ML^2T^{-2}]$

2. According to law of equipartition of energy the molar specific heat of a diatomic gas at constant volume where the molecule has one additional vibrational mode is :-

- (1)  $\frac{9}{2}R$       (2)  $\frac{5}{2}R$       (3)  $\frac{3}{2}R$       (4)  $\frac{7}{2}R$

**Official Ans. by NTA (4)**

**Ans. (4)**

**Sol.** Diatomic gas molecules have three translational degree of freedom, two rotational degree of freedom & it is given that it has one vibrational mode so there are two additional degree of freedom corresponding to one vibrational mode, so total degree of freedom = 7

$$C_v = \frac{fR}{2} = \frac{7R}{2}$$

3. The light rays from an object have been reflected towards an observer from a standard flat mirror, the image observed by the observer are :-

- A. Real
- B. Erect
- C. Smaller in size than object
- D. Laterally inverted

Choose the most appropriate answer from the options given below :

- (1) B and D only                      (2) B and C only
- (3) A and D only                      (4) A, C and D only

**Official Ans. by NTA (1)**

**Ans. (1)**

**Sol.** Plane mirror forms erect, same sized, laterally inverted and virtual image of real object.

4. For a moving coil galvanometer, the deflection in the coil is 0.05 rad when a current of 10 mA is passed through it. If the torsional constant of suspension wire is  $4.0 \times 10^{-5} \text{ Nm rad}^{-1}$ , the magnetic field is 0.01 T and the number of turns in the coil is 200, the area of each turn (in  $\text{cm}^2$ ) is :

- (1) 2.0                                      (2) 1.0
- (3) 1.5                                      (4) 0.5

**Official Ans. by NTA (2)**

**Ans. (2)**

**Sol.**  $\tau = K\theta$   
 $NiAB = K\theta$

$$A = \frac{K\theta}{NiB} = \frac{4 \times 10^{-5} \times 0.05}{200 \times 10 \times 10^{-3} \times 0.01}$$

On solving  $A = 10^{-4} \text{ m}^2 = 1 \text{ cm}^2$



5. The graph between two temperature scales P and Q is shown in the figure. Between upper fixed point and lower fixed point there are 150 equal divisions of scale P and 100 divisions on scale Q. The relationship for conversion between the two scales is given by :

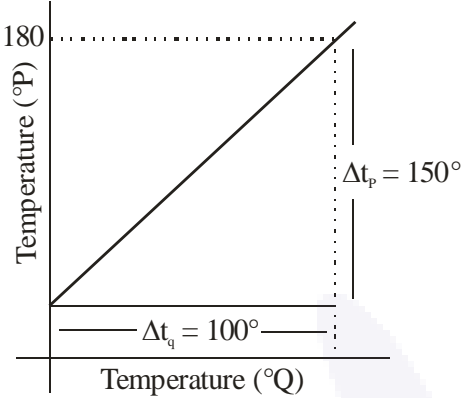

- (1)  $\frac{t_Q}{150} = \frac{t_P - 180}{100}$       (2)  $\frac{t_Q}{100} = \frac{t_P - 30}{150}$   
 (3)  $\frac{t_P}{180} = \frac{t_Q - 40}{100}$       (4)  $\frac{t_P}{100} = \frac{t_Q - 180}{150}$

**Official Ans. by NTA (2)**

**Ans. (2)**

**Sol.**  $\frac{\text{reading on scale} - \text{Lower fixed point}}{\text{upper fixed point} - \text{lower fixed point}} = \text{constant}$

$$\frac{t_P - 30}{180 - 30} = \frac{t_Q - 0}{100 - 0}$$

$$\frac{t_P - 30}{150} = \frac{t_Q}{100}$$

6. Match List I with List II :

A.	Gauss's Law in Electrostatics	I.	$\oint \vec{E} \cdot d\vec{l} = -\frac{d\phi_B}{dt}$
B.	Faraday's Law	II.	$\oint \vec{B} \cdot d\vec{A} = 0$
C.	Gauss's Law in Magnetism	III.	$\oint \vec{B} \cdot d\vec{l} = \mu_0 i_C + \mu_0 \epsilon_0 \frac{d\phi_E}{dt}$
D.	Ampere-Maxwell Law	IV.	$\oint \vec{E} \cdot d\vec{s} = \frac{q}{\epsilon_0}$

Choose the correct answer from the options given below :

- (1) A-IV, B-I, C-II, D-III  
 (2) A-I, B-II, C-III, D-IV  
 (3) A-III, B-IV, C-I, D-II  
 (4) A-II, B-III, C-IV, D-I

**Official Ans. by NTA (1)**

**Ans. (1)**

**Sol.** Gauss's Law of electrostatic

$$\phi = \oint \vec{E} \cdot d\vec{s} = \frac{q}{\epsilon_0}$$

Faraday's law  $\oint \vec{E} \cdot d\vec{l} = -\frac{d\phi_B}{dt}$

Gauss's law of magnetism  $\oint \vec{B} \cdot d\vec{A} = 0$

Ampere's Maxwell law

$$\oint \vec{B} \cdot d\vec{l} = \mu_0 i_C + \mu_0 \epsilon_0 \frac{d\phi_E}{dt}$$

Where  $i_C$  : Conduction current

$\epsilon_0 \frac{d\phi_E}{dt}$  : Displacement current

7. **Statement I** : When a Si sample is doped with Boron, it becomes P type and when doped by Arsenic it becomes N-type semi conductor such that P-type has excess holes and N-type has excess electrons.

**Statement II** : When such P-type and N-type semi-conductors, are fused to make a junction, a current will automatically flow which can be detected with an externally connected ammeter.

In the light of above statements, choose the most appropriate answer from the options given below.

Options:

- (1) Both Statement I and statement II are incorrect  
 (2) Statement I is incorrect but statement II is correct  
 (3) Both Statement I and statement II are correct  
 (4) Statement I is correct but statement II is incorrect

**Official Ans. by NTA (4)**

**Ans. (4)**

**Sol.** Statement – I is correct

When P-N junction is formed an electric field is generated from N-side to P-side due to which barrier potential arises & majority charge carrier can not flow through the junction due to barrier potential so current is zero unless we apply forward bias voltage.

8. Consider a block kept on an inclined plane (inclined at  $45^\circ$ ) as shown in the figure. If the force required to just push it up the incline is 2 times the force required to just prevent it from sliding down, the coefficient of friction between the block and inclined plane ( $\mu$ ) is equal to :

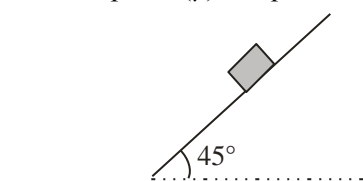

- (1) 0.33
- (2) 0.60
- (3) 0.25
- (4) 0.50

**Official Ans. by NTA (1)**

**Ans. (1)**

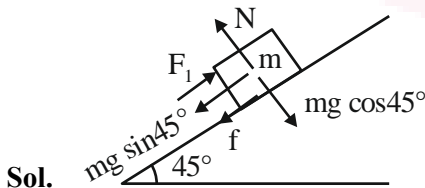

**Sol.**  $F_1 = mg \sin 45^\circ + f = mg \sin 45^\circ + \mu N$

$$F_1 = \frac{mg}{\sqrt{2}} + \mu mg \cos 45^\circ$$

$$F_1 = \frac{mg}{\sqrt{2}} (1 + \mu)$$

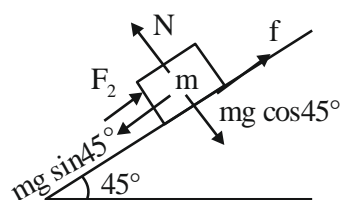

$$F_2 = mg \sin 45^\circ - f = mg \sin 45^\circ - \mu N$$

$$= \frac{mg}{\sqrt{2}} (1 - \mu)$$

$$F_1 = 2F_2$$

$$\frac{mg}{\sqrt{2}} (1 + \mu) = 2 \frac{mg}{\sqrt{2}} (1 - \mu)$$

$$1 + \mu = 2 - 2\mu$$

$$\mu = 1/3 = 0.33$$

9. A point charge of  $10 \mu\text{C}$  is placed at the origin. At what location on the X-axis should a point charge of  $40 \mu\text{C}$  be placed so that the net electric field is zero at  $x = 2 \text{ cm}$  on the X-axis ?

- (1)  $x = 6 \text{ cm}$
- (2)  $x = 4 \text{ cm}$
- (3)  $x = 8 \text{ cm}$
- (4)  $x = -4 \text{ cm}$

**Official Ans. by NTA (1)**

**Ans. (1)**

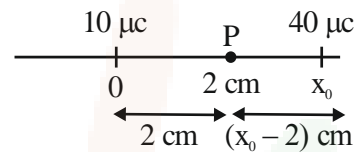

**Sol.**

$$E_P = \frac{K \times 10}{2^2} - \frac{K \times 40}{(x_0 - 2)^2} = 0$$

$$\frac{1}{2} = \frac{2}{x_0 - 2}$$

$$x_0 - 2 = 4$$

$$x_0 = 6 \text{ cm}$$

10. The energy levels of an atom is shown in figure. Which one of these transitions will result in the emission of a photon of wavelength  $124.1 \text{ nm}$  ? Given ( $h = 6.62 \times 10^{-34} \text{ Js}$ )

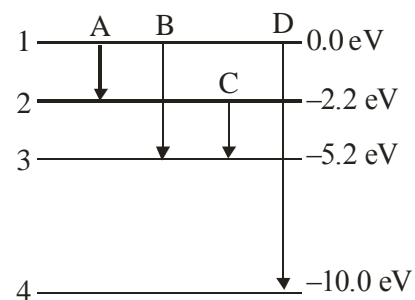

- (1) B
- (2) A
- (3) C
- (4) D

**Official Ans. by NTA (4)**

**Ans. (4)**

Sol.  $\lambda = \frac{hc}{\Delta E}$

$\Delta E_A = 2.2 \text{ eV}$

$\Delta E_B = 5.2 \text{ eV}$

$\Delta E_C = 3 \text{ eV}$

$\Delta E_D = 10 \text{ eV}$

$\lambda_A = \frac{6.62 \times 10^{-34} \times 3 \times 10^8}{2.2 \times 1.6 \times 10^{-19}}$

$= \frac{12.41 \times 10^{-7}}{2.2} \text{ m}$

$= \frac{1241}{2.2} \text{ nm} = 564 \text{ nm}$

$\lambda_B = \frac{1241}{5.2} \text{ nm} = 238.65 \text{ nm}$

$\lambda_C = \frac{1241}{3} \text{ nm} = 413.66 \text{ nm}$

$\lambda_D = \frac{1241}{10} = 124.1 \text{ nm}$

11. A particle executes simple harmonic motion between  $x = -A$  and  $x = +A$ . If time taken by particle to go from  $x = 0$  to  $\frac{A}{2}$  is 2s; then time

taken by particle in going from  $x = \frac{A}{2}$  to  $A$  is :

- (1) 3 s                                      (2) 2 s
- (3) 1.5 s                                    (4) 4 s

Official Ans. by NTA (4)

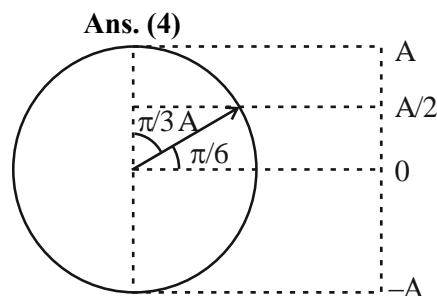

Sol.

Let time from 0 to  $A/2$  is  $t_1$

& from  $A/2$  to  $A$  is  $t_2$

then  $\omega t_1 = \pi/6$

$\omega t_2 = \pi/3$

$\frac{t_1}{t_2} = \frac{1}{2}$

$t_2 = 2t_1 = 2 \times 2 = 4 \text{ sec}$

12. Match List I with List II :

	List I		List II
A.	Isothermal Process	I.	Work done by the gas decreases internal energy
B.	Adiabatic Process	II.	No change in internal energy
C.	Isochoric Process	III.	The heat absorbed goes partly to increase internal energy and partly to do work
D.	Isobaric Process	IV.	No work is done on or by the gas

Choose the correct answer from the options given below :

- (1) A-II, B-I, C-III, D-IV
- (2) A-II, B-I, C-IV, D-III
- (3) A-I, B-II, C-IV, D-III
- (4) A-I, B-II, C-III, D-IV

Official Ans. by NTA (2)

Ans. (2)

Sol.  $\Delta U = nC_V \Delta T$

For isothermal process  $T$  is constant

So  $\Delta U = 0$

A  $\longrightarrow$  II

Adiabatic process

$\Delta Q = 0$

$\Delta Q = \Delta U + \Delta W$

$\Delta U = -\Delta W$

Work done by gas is positive

So  $\Delta U$  is negative

B  $\longrightarrow$  I

For Isochoric process  $\Delta W = 0$

C  $\longrightarrow$  IV

For Isobaric process

$\Delta W = P\Delta V \neq 0$

$\Delta U = nC_V \Delta T \neq 0$

Heat absorbed goes partly to increase internal energy and partly do work.



13. Match List I with List II

	List I		List II
A.	Troposphere	I.	Approximate 65-75 km over Earth's surface
B.	E-Part of Stratosphere	II.	Approximate 300 km over Earth's surface
C.	F <sub>2</sub> -Part of Thermosphere	III.	Approximate 10 km over Earth's surface
D.	D-Part of Stratosphere	IV.	Approximate 100 km over Earth's surface

Choose the correct answer from the options given below :

- (1) A-III, B-IV, C-II, D-I
- (2) A-I, B-II, C-IV, D-III
- (3) A-I, B-IV, C-III, D-II
- (4) A-III, B-II, C-I, D-IV

**Official Ans. by NTA (1)**

**Ans. (1)**

**Sol.** NCERT fact based

14. A body of mass is taken from earth surface to the height h equal to twice the radius of earth (R<sub>e</sub>), the increase in potential energy will be :  
(g = acceleration due to gravity on the surface of Earth)

- (1) 3mgR<sub>e</sub>
- (2)  $\frac{1}{3}mgR_e$
- (3)  $\frac{2}{3}mgR_e$
- (4)  $\frac{1}{2}mgR_e$

**Official Ans. by NTA (3)**

**Ans. (3)**

**Sol.**  $U = \frac{-GM_e m}{r}$

$U_i = \frac{-GM_e m}{R_e}$

$U_f = \frac{-GM_e m}{(R_e + h)} = \frac{-GM_e m}{R_e + 2R_e}$

$\frac{-GM_e m}{3R_e}$

Increase in internal energy  $\Delta U = U_f - U_i$

$= \frac{2}{3} \frac{GM_e m}{R_e}$

$\frac{2}{3} \frac{GM_e}{R_e^2} m R_e$

$= \frac{2}{3} mgR_e$

15. A wire of length 1 m moving with velocity 8 m/s at right angles to a magnetic field of 2T. The magnitude of induced emf, between the ends of wire will be \_\_\_\_\_ :

- (1) 20 V
- (2) 8 V
- (3) 12 V
- (4) 16 V

**Official Ans. by NTA (4)**

**Ans. (4)**

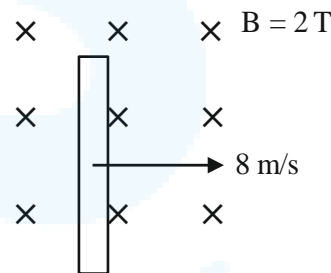

**Sol.**  $\times \quad \times \quad \times$

Induced emf across the ends =  $Bv\ell$

$= 2 \times 8 \times 1 = 16 \text{ V}$

16. The distance travelled by a particle is related to time t as  $x = 4t^2$ . The velocity of the particle at t = 5s is .

- (1) 40 ms<sup>-1</sup>
- (2) 25 ms<sup>-1</sup>
- (3) 20 ms<sup>-1</sup>
- (4) 8 ms<sup>-1</sup>

**Official Ans. by NTA (1)**

**Ans. (1)**

**Sol.**  $x = 4t^2$

$v = \frac{dx}{dt} = 8t$

At t = 5 sec

$v = 8 \times 5 = 40 \text{ m/s.}$



17. Two objects are projected with same velocity 'u' however at different angles  $\alpha$  and  $\beta$  with the horizontal. If  $\alpha + \beta = 90^\circ$ , the ratio of horizontal range of the first object to the 2<sup>nd</sup> object will be :

- (1) 4 : 1                      (2) 2 : 1  
 (3) 1 : 2                      (4) 1 : 1

**Official Ans. by NTA (4)**

**Ans. (4)**

**Sol.** Range =  $\frac{u^2 \sin 2\theta}{g}$

Range for projection angle "α"

$$R_1 = \frac{u^2 \sin 2\alpha}{g}$$

Range for projection angle "β"

$$R_2 = \frac{u^2 \sin 2\beta}{g}$$

$\alpha + \beta = 90^\circ$  (Given)

$$\Rightarrow \boxed{\beta = 90^\circ - \alpha}$$

$$R_2 = \frac{u^2 \sin 2(90^\circ - \alpha)}{g}$$

$$R_2 = \frac{u^2 \sin(180^\circ - 2\alpha)}{g}$$

$$R_2 = \frac{u^2 \sin 2\alpha}{g}$$

$$\Rightarrow \frac{R_1}{R_2} = \frac{\left(\frac{u^2 \sin 2\alpha}{g}\right)}{\left(\frac{u^2 \sin 2\alpha}{g}\right)} = \frac{1}{1}$$

18. The resistance of a wire is 5 Ω. It's new resistance in ohm if stretched to 5 times of it's original length will be :

- (1) 625      (2) 5      (3) 125      (4) 25

**Official Ans. by NTA (3)**

**Ans. (3)**

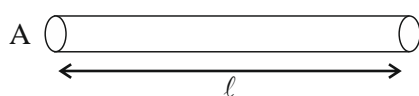

**Sol.**

$$R_{\text{initial}} = \frac{\rho l}{A} = 5\Omega$$

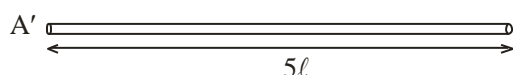

$\therefore$  Volume of wire is constant in stretching

$$V_i = V_f$$

$$A_i l_i = A_f l_f$$

$$A l = A'(5l)$$

$$A' = \frac{A}{5}$$

$$R_f = \frac{\rho l_f}{A_f} = \frac{\rho(5l)}{\left(\frac{A}{5}\right)}$$

$$= 25 \left(\frac{\rho l}{A}\right)$$

$$= 25 \times 5 = 125 \Omega$$

19. Given below are two statements :

**Statement I :** Stopping potential in photoelectric effect does not depend on the power of the light source.

**Statement II :** For a given metal, the maximum kinetic energy of the photoelectron depends on the wavelength of the incident light.

In the light of above statements, choose the most appropriate answer from the options given below.

Options :

- (1) Statement I is incorrect but statement II is correct  
 (2) Both Statement I and Statement II are incorrect  
 (3) Statement I is correct but statement II is incorrect  
 (4) Both statement I and statement II are correct

**Official Ans. by NTA (4)**

**Ans. (4)**

**Sol.** Stopping potential  $V_s = \frac{KE_{\text{max}}}{e}$

$$V_s = \frac{\frac{hc}{\lambda} - \phi}{e}$$

Stopping potential does not depend on intensity or power of light used, it only depends on frequency or wavelength of incident light.

So both statements I and II are correct

20. Every planet revolves around the sun in an elliptical orbit :

A. The force acting on a planet is inversely proportional to square of distance from sun.

B. Force acting on planet is inversely proportional to product of the masses of the planet and the sun

C. The centripetal force acting on the planet is directed away from the sun.

D. The square of time period of revolution of planet around sun is directly proportional to cube of semi-major axis of elliptical orbit.

Choose the correct answer from the options given below :

Options :

(1) A and D only                      (2) C and D only

(3) B and C only                      (4) A and C only

Official Ans. by NTA (1)

Ans. (1)

Sol.  $F = \frac{Gm_1m_2}{r^2}$

$\Rightarrow F \propto \frac{1}{r^2}$

$\Rightarrow F \propto m_1m_2$

$\Rightarrow$  This force provides centripetal force and acts towards sun

$\Rightarrow T^2 \propto a^3$  (Kepler's third law)

SECTION-B

21. A capacitor has capacitance  $5\mu\text{F}$  when its parallel plates are separated by air medium of thickness  $d$ .

A slab of material of dielectric constant 1.5 having area equal to that of plates but thickness  $\frac{d}{2}$  is inserted between the plates. Capacitance of the capacitor in the presence of slab will be \_\_\_\_\_  $\mu\text{F}$ .

Official Ans. by NTA (6)

Ans. (6)

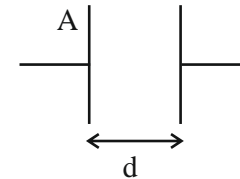
Sol.   $\frac{\epsilon_0 A}{d} = 5\mu\text{F}$

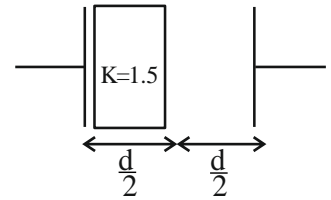

$$C_{\text{new}} = \frac{\epsilon_0 A}{\left(\frac{d}{2}\right) + \frac{\left(\frac{d}{2}\right)}{1.5}}$$

$$= \frac{\epsilon_0 A}{\left(\frac{d}{3} + \frac{d}{2}\right)} = \frac{6\epsilon_0 A}{5d}$$

$$= \frac{6}{5} \times 5\mu\text{F} = 6\mu\text{F}$$

22. A train blowing a whistle of frequency 320 Hz approaches an observer standing on the platform at a speed of 66 m/s. The frequency observed by the observer will be (given speed of sound =  $330 \text{ ms}^{-1}$ ) \_\_\_\_\_ Hz.

Official Ans. by NTA (400)

Ans. (400)

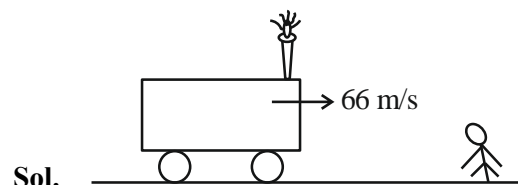

$$f_{\text{app}} = f \left( \frac{v}{v - v_s} \right)$$

$$= 320 \left( \frac{330}{330 - 66} \right)$$

$$= 400 \text{ Hz}$$

23. An object is placed on the principal axis of convex lens of focal length 10 cm as shown. A plane mirror is placed on the other side of lens at a distance of 20 cm. The image produced by the plane mirror is 5 cm inside the mirror. The distance of the object from the lens is \_\_\_\_ cm.

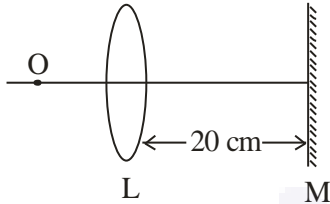

Official Ans. by NTA (30)

Ans. (30)

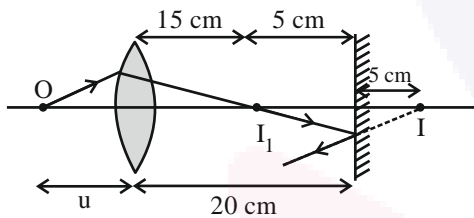

Sol.

$$f = 10 \text{ cm}$$

$$\frac{1}{v} - \frac{1}{u} = \frac{1}{f}$$

$$\frac{1}{15} - \frac{1}{-u} = \frac{1}{10}$$

$$\Rightarrow \frac{1}{u} = \frac{1}{10} - \frac{1}{15}$$

On solving we get value of u as 30 cm.

24. Two long parallel wires carrying currents 8A and 15 A in opposite directions are placed at a distance of 7 cm from each other. A point P is at equidistant from both the wires such that the lines joining the point P to the wires are perpendicular to each other. The magnitude of magnetic field at P is \_\_\_\_  $\times 10^{-6}$  T. (Given :  $\sqrt{2} = 1.4$ )

Official Ans. by NTA (68)

Ans. (68)

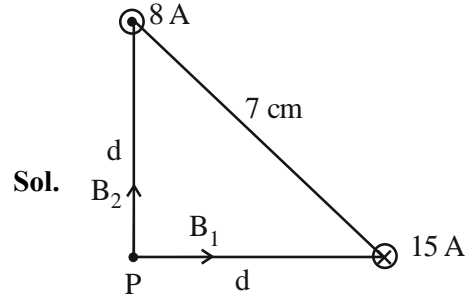

Sol.

Magnetic fields due to both wires will be perpendicular to each other.

$$B_1 = \frac{\mu_0 i_1}{2\pi d} \quad B_2 = \frac{\mu_0 i_2}{2\pi d}$$

$$B_{\text{net}} = \sqrt{B_1^2 + B_2^2} \Rightarrow \frac{\mu_0}{2\pi d} \sqrt{i_1^2 + i_2^2}$$

$$\Rightarrow \frac{4\pi \times 10^{-7}}{2\pi \times (7/\sqrt{2}) \times 10^{-2}} \times \sqrt{8^2 + 15^2} \quad (d = \frac{7}{\sqrt{2}} \text{ cm})$$

$$\Rightarrow 68 \times 10^{-6} \text{ T}$$

25. A spherical drop of liquid splits into 1000 identical spherical drops. If  $u_i$  is the surface energy of the original drop and  $u_f$  is the total surface energy of the resulting drops, the (ignoring evaporation).

$$\frac{u_f}{u_i} = \left(\frac{10}{x}\right). \text{ Then value of } x \text{ is } \underline{\hspace{2cm}} :$$

Official Ans. by NTA (1)

Ans. (1)

Sol. Surface Tension = T

R : Radius of bigger drop

r : Radius of smaller drop

Volume will remain same

$$\frac{4}{3}\pi R^3 = 1000 \times \frac{4}{3}\pi r^3$$

$$R = 10r$$

$$u_i = T \cdot 4\pi R^2$$

$$u_f = T \cdot 4\pi r^2 \times 1000$$

$$\frac{u_f}{u_i} = \frac{1000r^2}{R^2}$$

$$\frac{u_f}{u_i} = \frac{10}{1}$$

$$\text{So, } x = 1$$



26. A body of mass 1 kg collides head on elastically with a stationary body of mass 3 kg. After collision, the smaller body reverses its direction of motion and moves with a speed of 2m/s. The initial speed of the smaller body before collision is \_\_\_\_\_  $\text{ms}^{-1}$ .

Official Ans. by NTA (4)

Ans. (4)

Sol.

$$1 \times u_1 = -2 + 3v \Rightarrow u_1 = -2 + 3v \dots\dots (1)$$

$$1 = \frac{v+2}{u_1} \Rightarrow v+2 = u_1 \dots\dots (2)$$

Solving (1) and (2)

$$u_1 = 4 \text{ m/s}$$

27. A nucleus disintegrates into two smaller parts, which have their velocities in the ratio 3 : 2. The ratio of their nuclear sizes will be  $\left(\frac{x}{3}\right)^{\frac{1}{3}}$ . The

value of 'x' is :

Official Ans. by NTA (2)

Ans. (2)

Sol.

$$\frac{v_1}{v_2} = \frac{3}{2}$$

$$m_1 v_1 = m_2 v_2 \Rightarrow \frac{m_1}{m_2} = \frac{2}{3}$$

Since, Nuclear mass density is constant

$$\frac{m_1}{\frac{4}{3}\pi r_1^3} = \frac{m_2}{\frac{4}{3}\pi r_2^3}$$

$$\left(\frac{r_1}{r_2}\right)^3 = \frac{m_1}{m_2}$$

$$\frac{r_1}{r_2} = \left(\frac{2}{3}\right)^{\frac{1}{3}}$$

So, x = 2

28. Two cells are connected between points A and B as shown. Cell 1 has emf of 12 V and internal resistance of  $3\Omega$ . Cell 2 has emf of 6V and internal resistance of  $6\Omega$ . An external resistor R of  $4\Omega$  is connected across A and B. The current flowing through R will be \_\_\_\_\_ A.

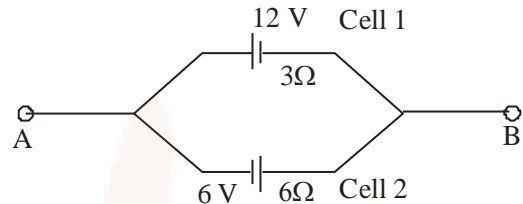

Official Ans. by NTA (1)

Ans. (1)

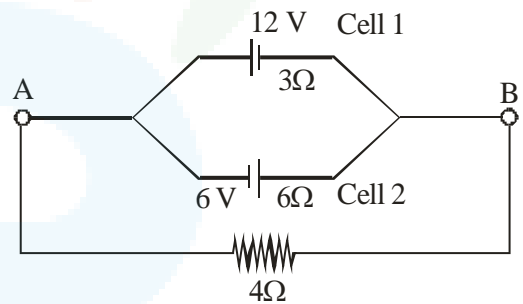

Sol.

$$E_{eq} = \frac{\frac{12}{3} - \frac{6}{6}}{\frac{1}{3} + \frac{1}{6}}$$

$$E_{eq} = 6V$$

$$r_{eq} = 2 \Omega$$

$$R = 4 \Omega$$

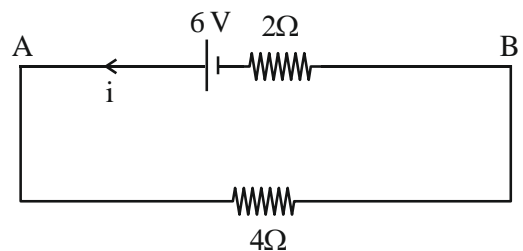

$$\text{So, } i = \frac{6}{2+4} = 1 \text{ A}$$

29. A series LCR circuit is connected to an AC source of 220 V, 50 Hz. The circuit contains a resistance  $R = 80\Omega$ , an inductor of inductive reactance  $X_L = 70\Omega$ , and a capacitor of capacitive reactance  $X_C = 130\Omega$ . The power factor of circuit is  $\frac{x}{10}$ .

The value of x is :

**Official Ans. by NTA (8)**

**Ans. (8)**

Sol.  $\cos\phi = \frac{R}{Z} = \frac{R}{\sqrt{R^2 + (X_C - X_L)^2}}$

$$\cos\phi = \frac{80}{\sqrt{(80)^2 + (60)^2}}$$

$$\cos\phi = \frac{80}{100} \Rightarrow \frac{8}{10}$$

So,  $x = 8$

30. If a solid sphere of mass 5 kg and a disc of mass 4 kg have the same radius. Then the ratio of moment of inertia of the disc about a tangent in its plane to the moment of inertia of the sphere about its tangent will be  $\frac{x}{7}$ . The value of x is \_\_\_\_\_.

**Official Ans. by NTA (5)**

**Ans. (5)**

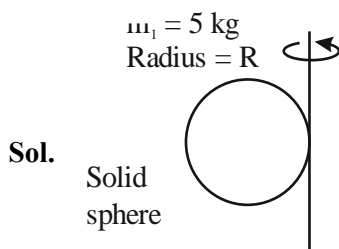

$$I_1 = \frac{2}{5}m_1R^2 + m_1R^2$$

$$I_1 = m_1R^2\left(\frac{7}{5}\right)$$

$$I_1 = 7R^2$$

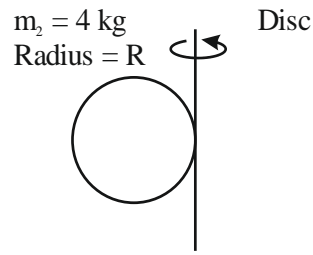

$$I_2 = \frac{m_2R^2}{4} + m_2R^2$$

$$I_2 = \frac{5}{4}m_2R^2$$

$$I_2 = 5R^2$$

$$\frac{I_2}{I_1} = \frac{5}{7}$$

$$x = 5$$